

# DZS 35/2 B

## DZQ/DZS/DZF..B standard (pravé otáčky, 1 rychlost)



SC - ochranný kontakt  
TK - termokontakt

## DZQ/DZS/DZF..B standard (levé otáčky, 1 rychlost)

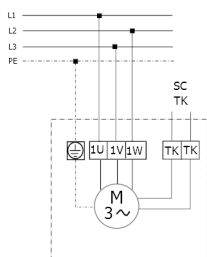

SC - ochranný kontakt  
TK - termokontakt

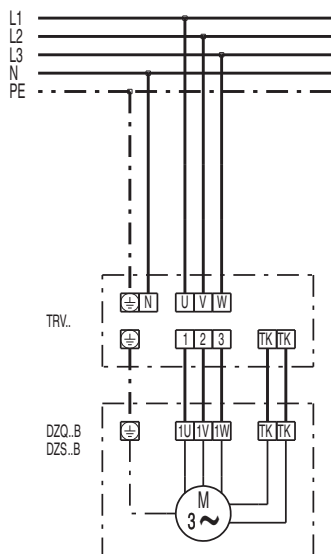



# SCHÉMA ZAPOJENÍ

## DZS 35/2 B

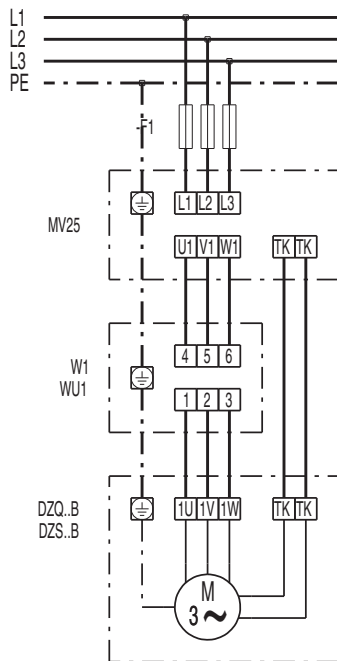

# SCHÉMA ZAPOJENÍ

## DZS 35/2 B



