

DZS 35/6 B

DZQ/DZS/DZF..B standard (pravé otáčky, 1 rychlost)



SC - ochranný kontakt
TK - termokontakt

DZQ/DZS/DZF..B standard (levé otáčky, 1 rychlost)

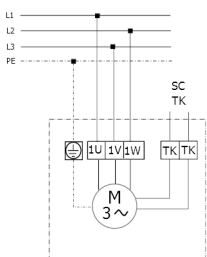

SC - ochranný kontakt
TK - termokontakt





SCHÉMA ZAPOJENÍ

DZS 35/6 B

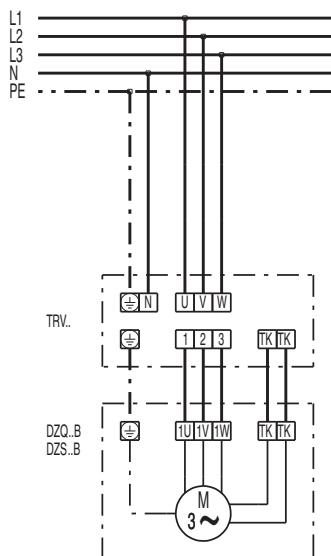

SCHÉMA ZAPOJENÍ

DZS 35/6 B



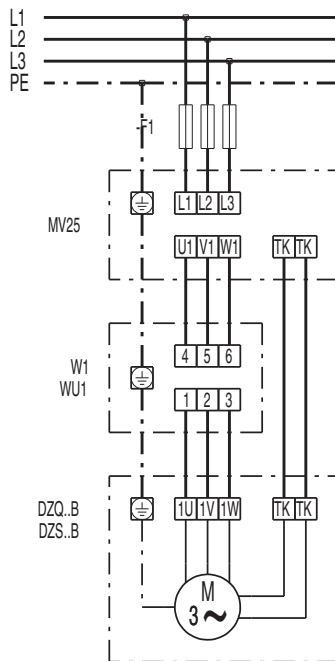