

SCHÉMA ZAPOJENÍ

EZF 30/6 B

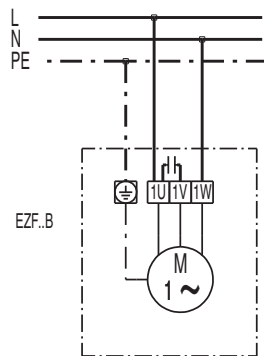

EZF 30/6 B

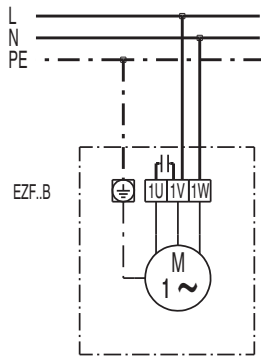

SCHÉMA ZAPOJENÍ

EZF 30/6 B



EZF 30/6 B

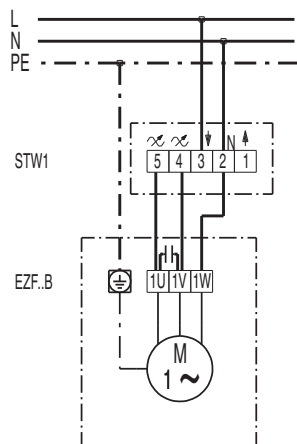
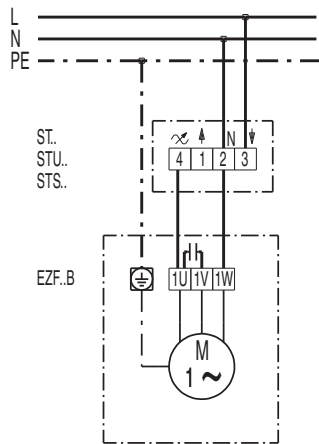
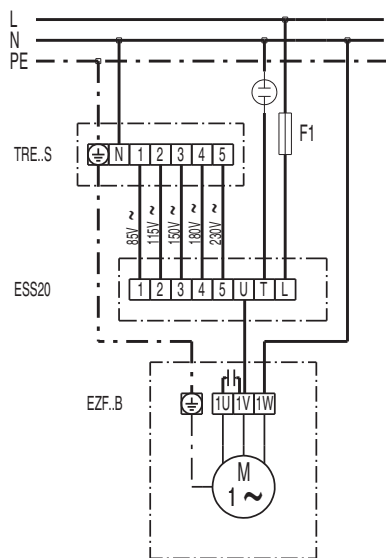
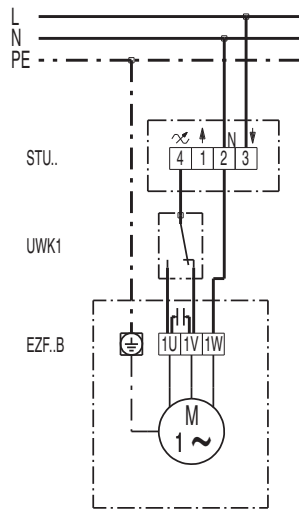
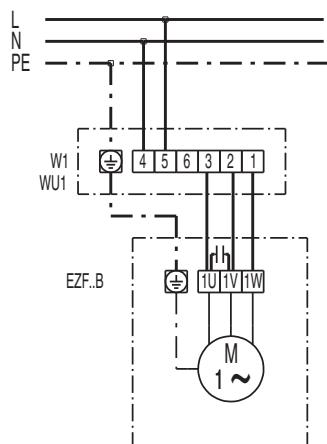
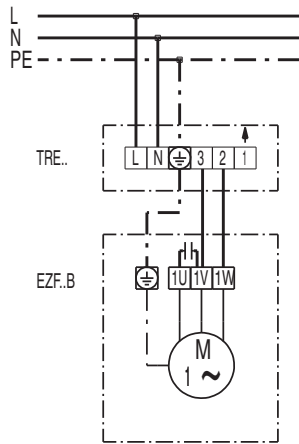

EZF 30/6 B



SCHÉMA ZAPOJENÍ

EZF 30/6 B

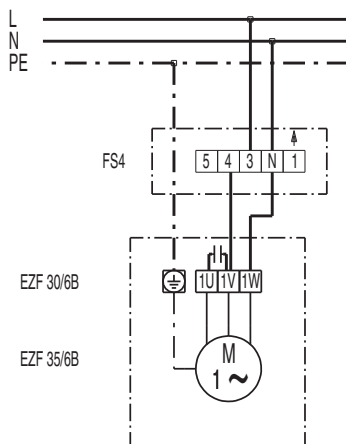
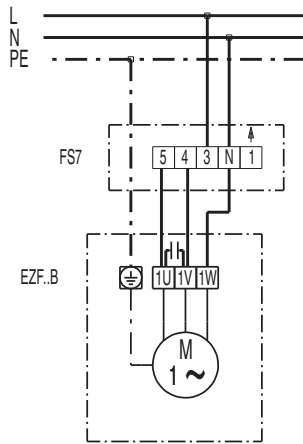