

SCHÉMA ZAPOJENÍ

EZF 35/6 B

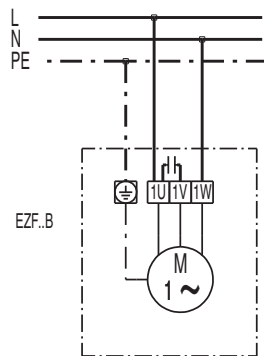

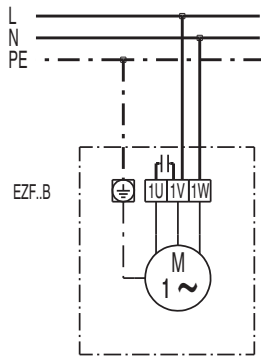

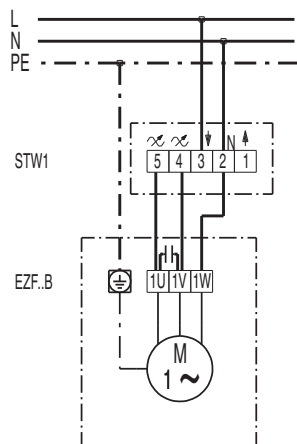
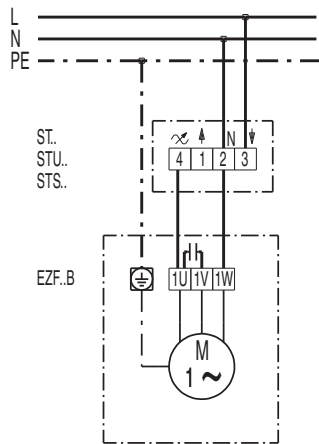

SCHÉMA ZAPOJENÍ

EZF 35/6 B



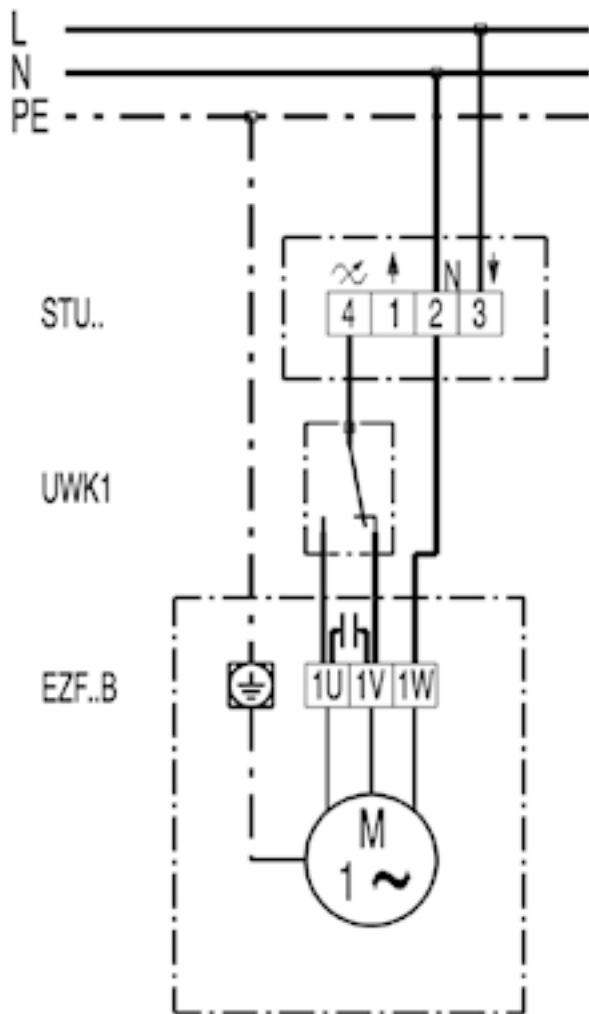
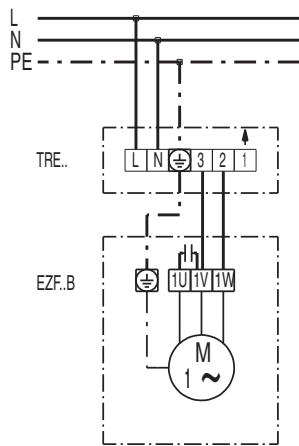
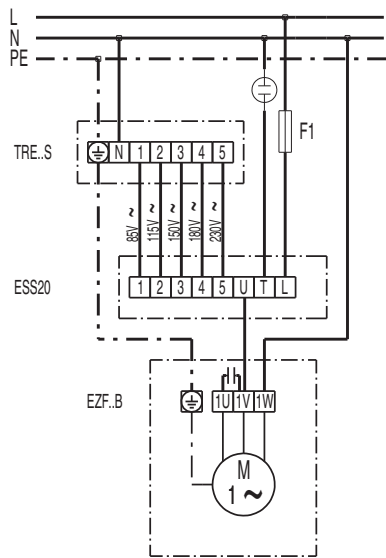

SCHÉMA ZAPOJENÍ

EZF 35/6 B

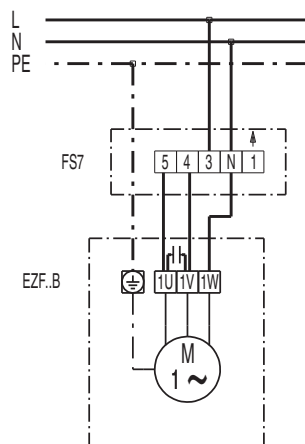
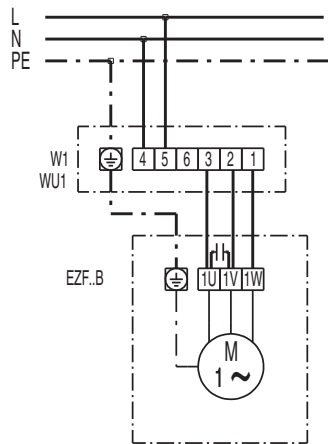