

SCHÉMA ZAPOJENÍ

EZF 45/6 B

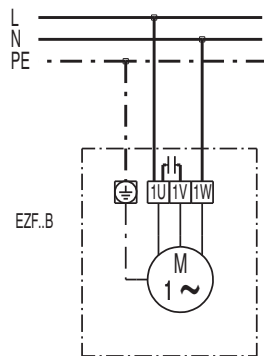

EZF 45/6 B

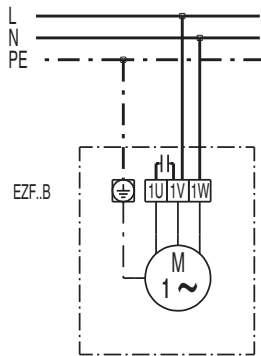
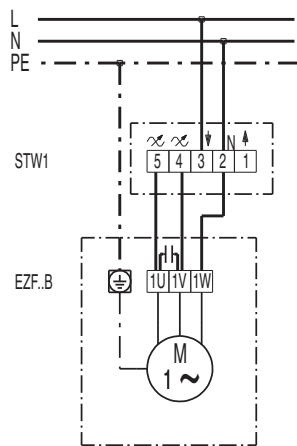
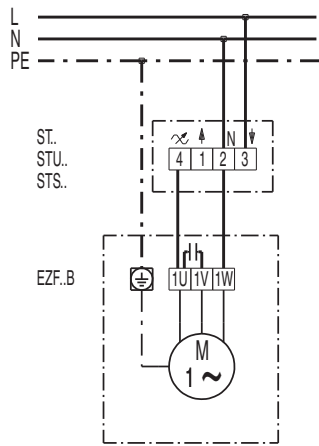

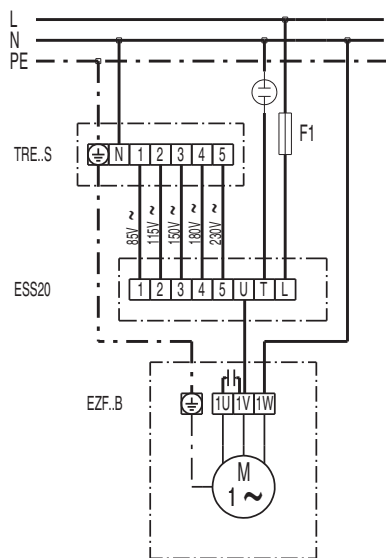
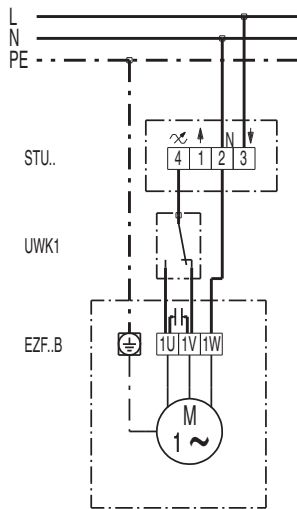

EZF 45/6 B



SCHÉMA ZAPOJENÍ

EZF 45/6 B

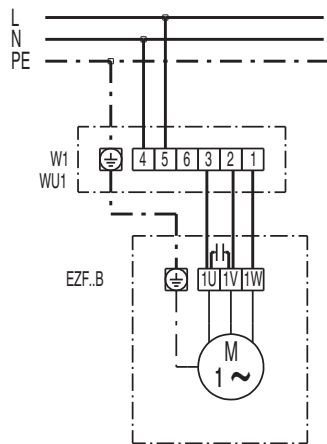
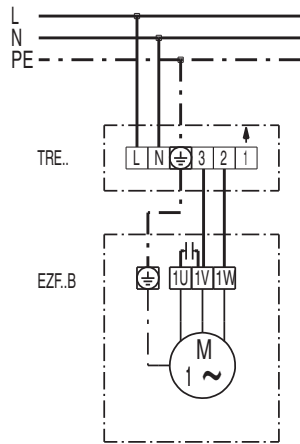