

SCHÉMA ZAPOJENÍ

EZF 50/6 B

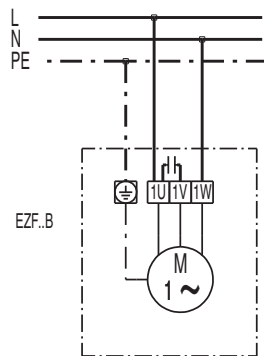

EZF 50/6 B

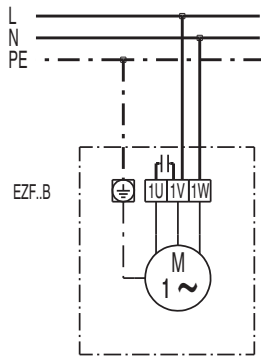
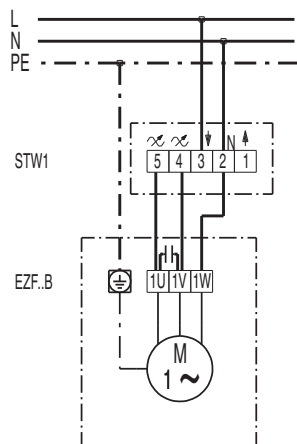
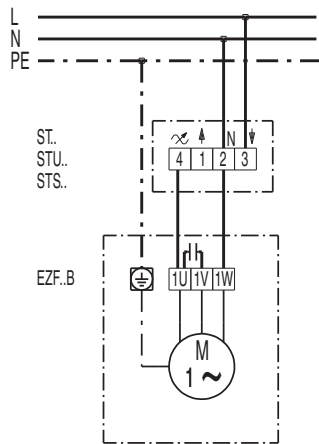

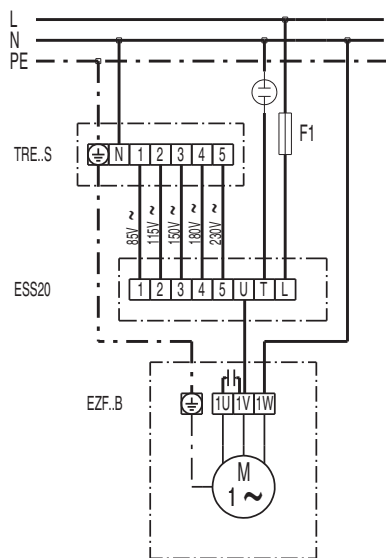
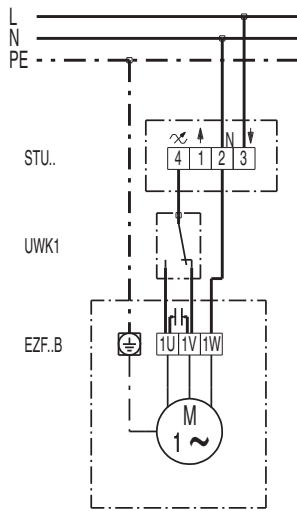

EZF 50/6 B



SCHÉMA ZAPOJENÍ

EZF 50/6 B

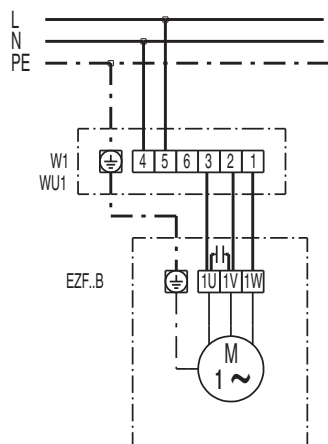
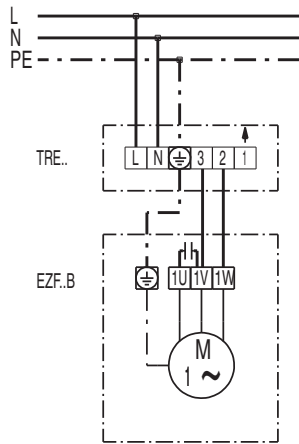