

EZS 20/2 B

EZQ / EZS..B pravé otáčky

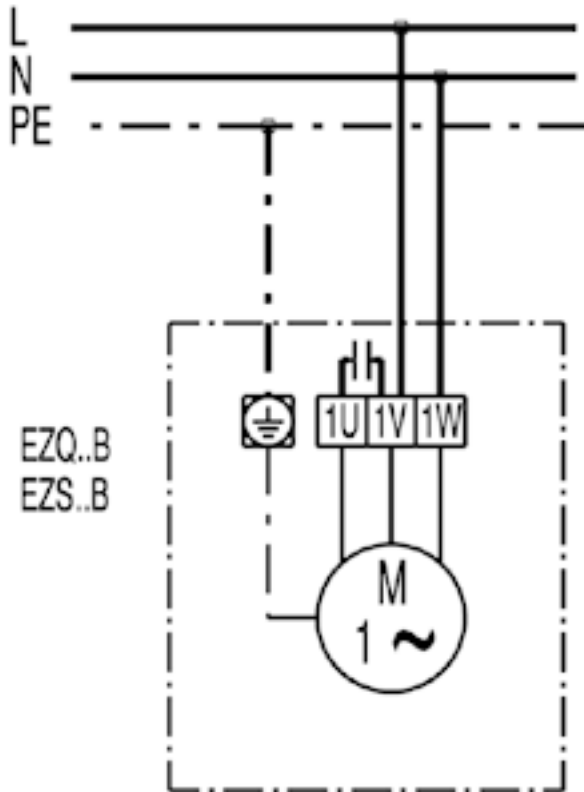

EZS 20/2 B

EZQ / EZS..B levé otáčky

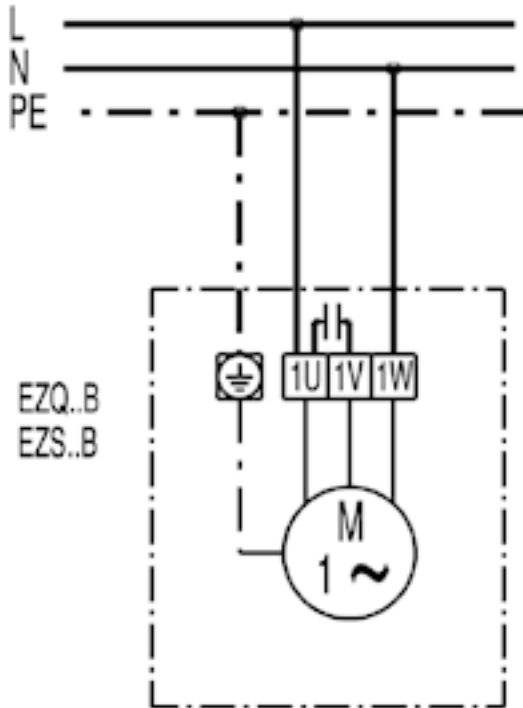

EZQ / EZS..B s regulací otáček ST/ STU / STS levé otáčky

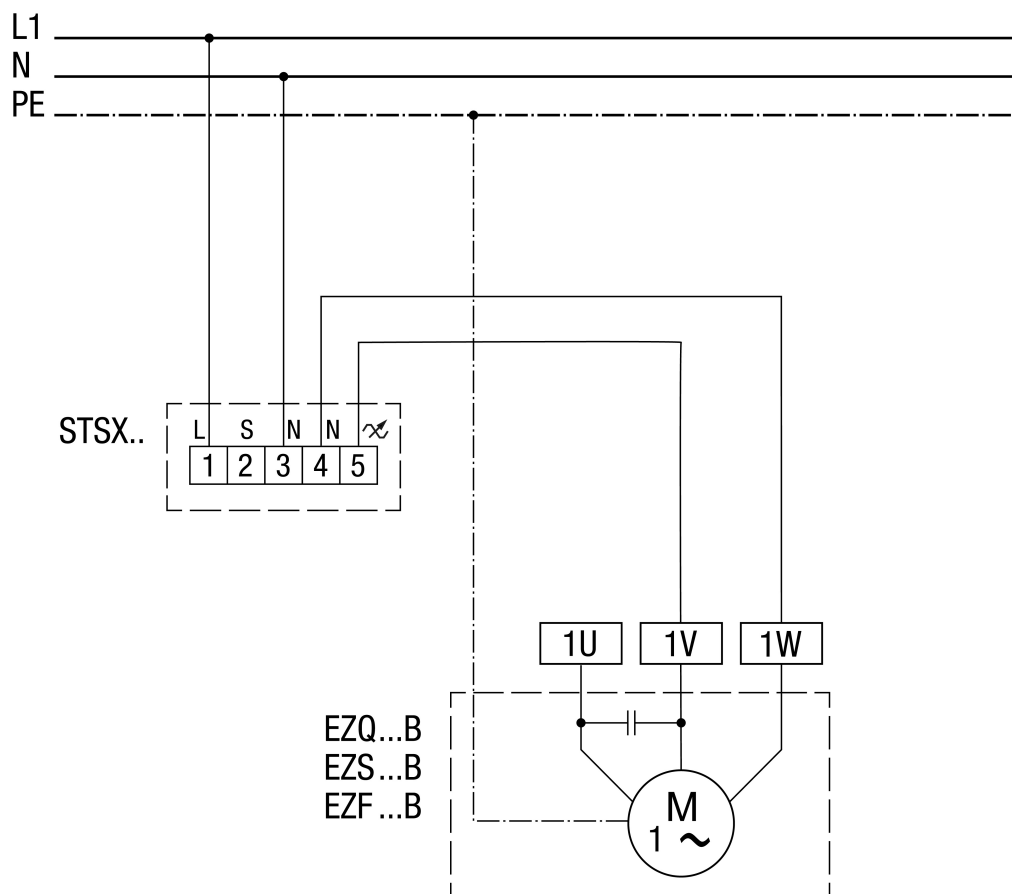

EZQ / EZS..B s regulátorem STW1

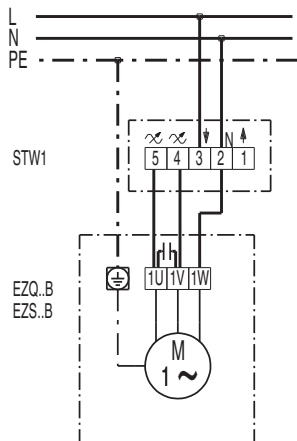

EZQ / EZS..B s reverzačním přepínačem UWK 1 a regulátorem STU..

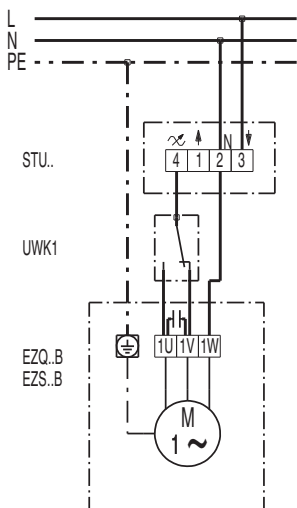

EZS 20/2 B

EZQ / EZS..B s 5-stupňovým transformátorem TRE..S/TR..S a 5-stupňovým spínačem ESS20

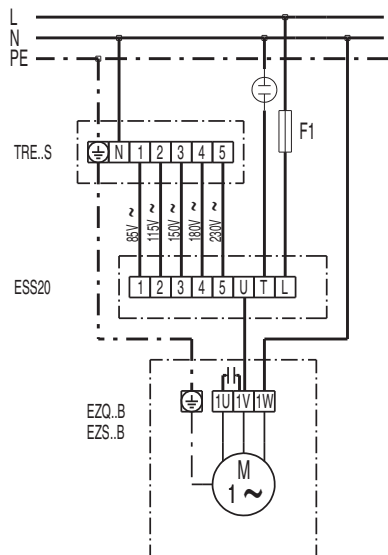

EZQ / EZS...B s 5-stupňovým transformátorem TRE..

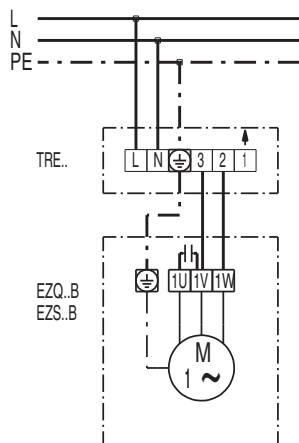

EZQ / EZS..B s reverz. přepínačem W1/ WU1

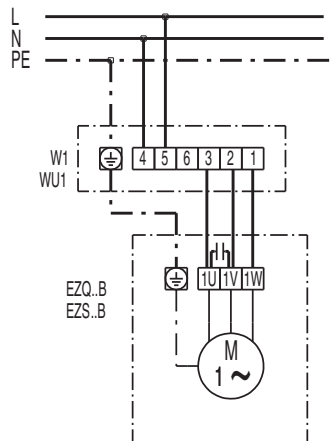

EZQ / EZS...B s reverz. přepínačem FS 7

