

# SCHÉMA ZAPOJENÍ

## EZS 30/6 B

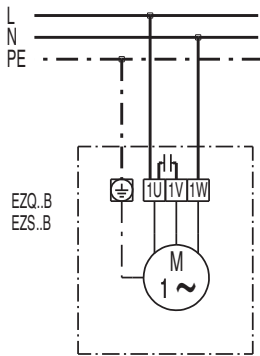

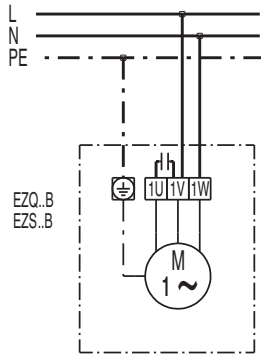
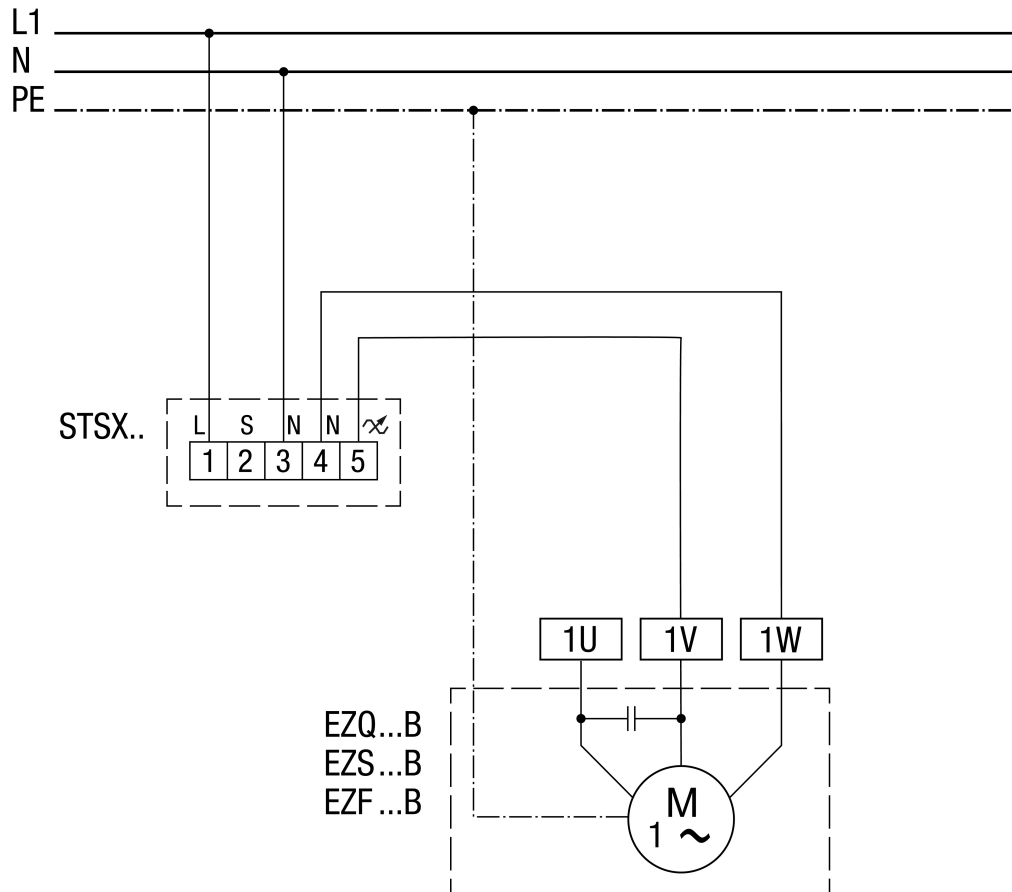

# SCHÉMA ZAPOJENÍ

## EZS 30/6 B

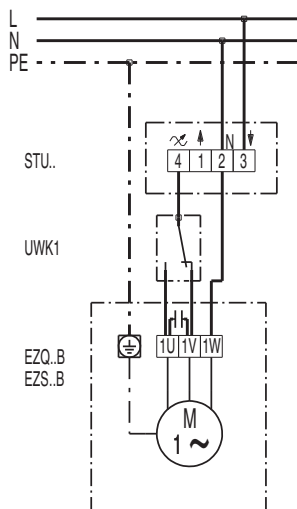
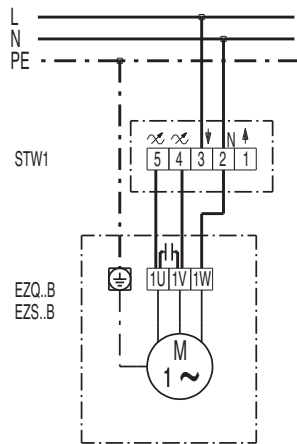

# SCHÉMA ZAPOJENÍ

## EZS 30/6 B

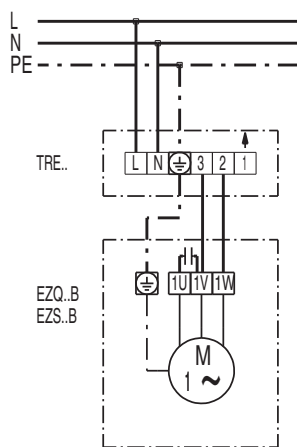
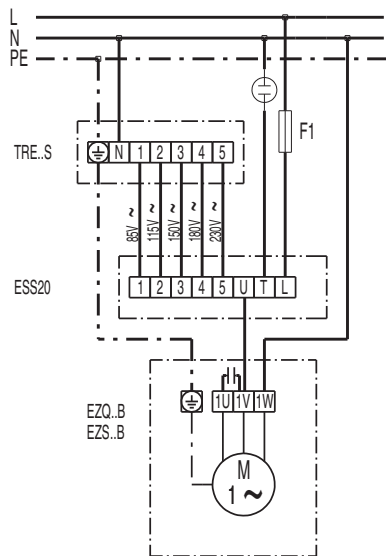

EZS 30/6 B

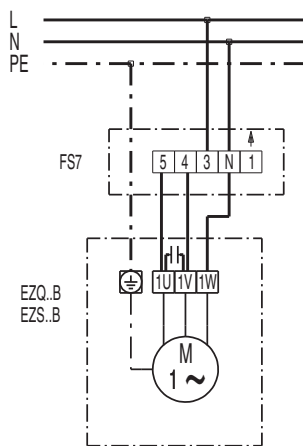
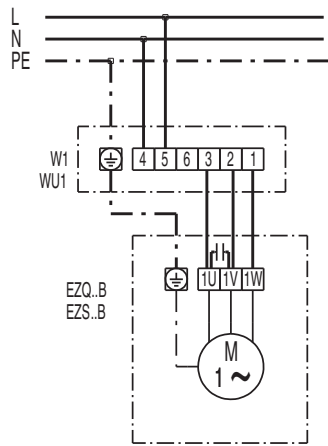

# SCHÉMA ZAPOJENÍ

## EZS 30/6 B

