

SCHÉMA ZAPOJENÍ

EZS 35/6 B

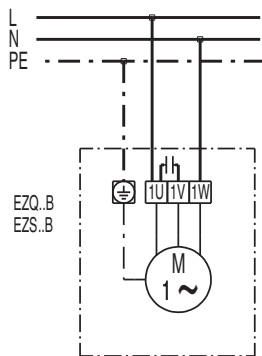

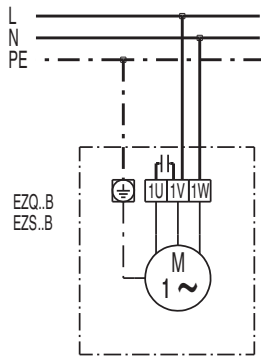

SCHÉMA ZAPOJENÍ

EZS 35/6 B

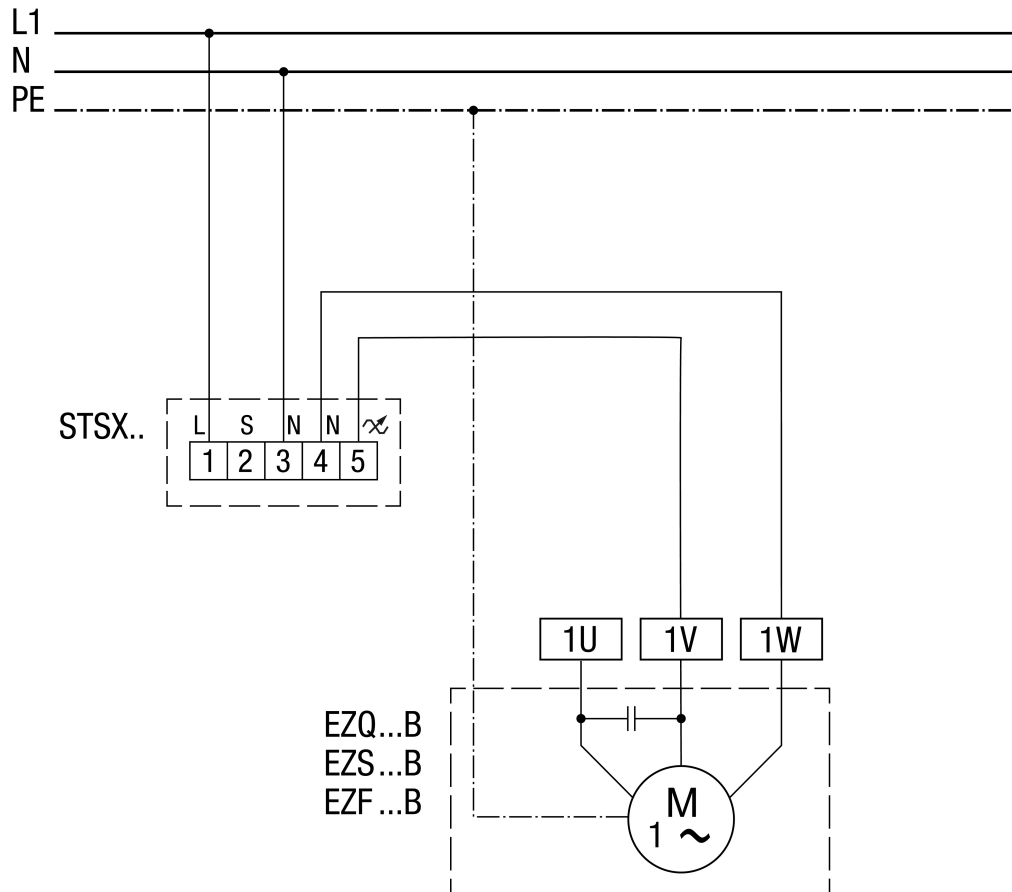

SCHÉMA ZAPOJENÍ

EZS 35/6 B

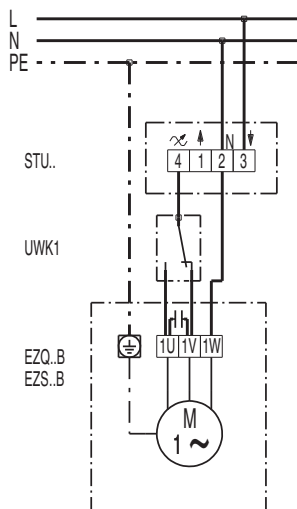
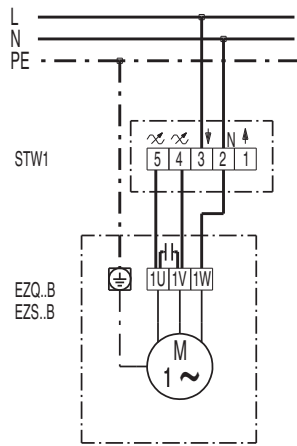

SCHÉMA ZAPOJENÍ

EZS 35/6 B

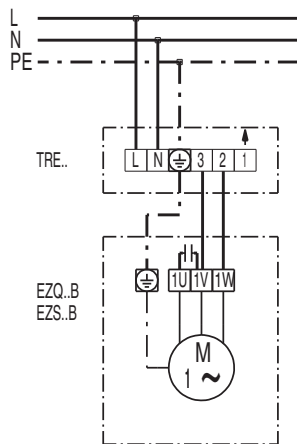
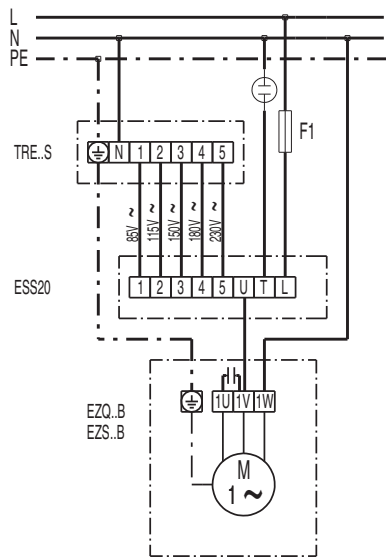

SCHÉMA ZAPOJENÍ

EZS 35/6 B

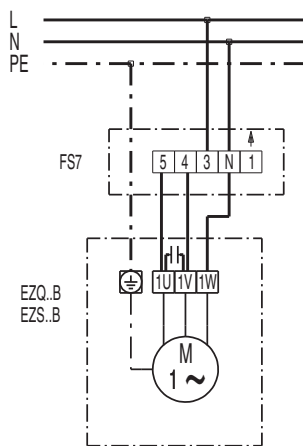
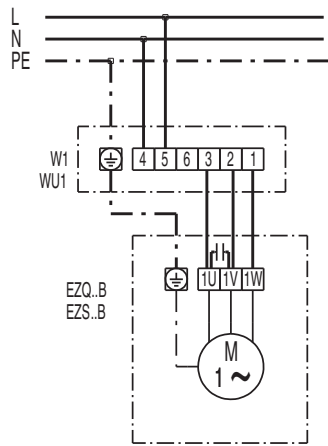