

# SCHALTBILDER

## DZR 30/64 B

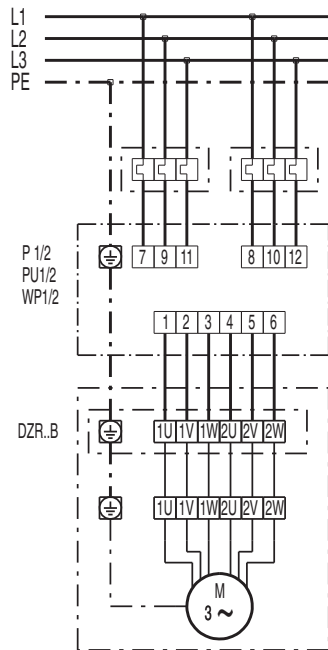

# SCHALTBILDER

## DZR 30/64 B

