

# SCHALTBILDER

## DZR 35/84 B

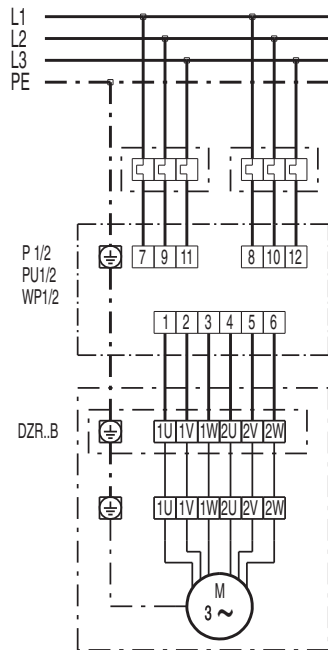

# SCHALTBILDER

## DZR 35/84 B

