

SCHALTBILDER

DZR 50/86 B

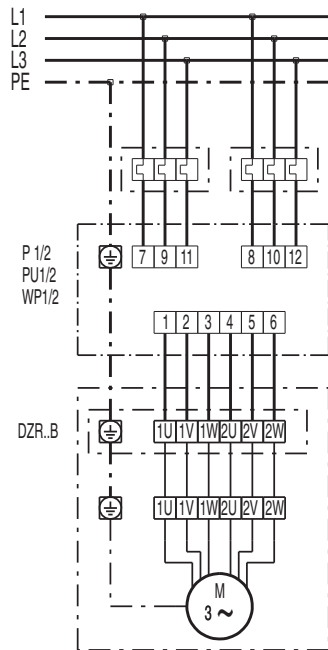

SCHALTBILDER

DZR 50/86 B

