

SCHALTBILDER

EZF 50/6 B

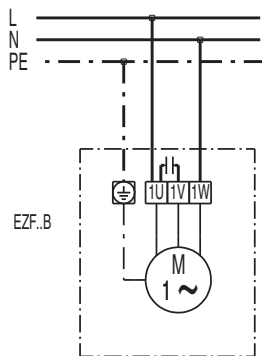
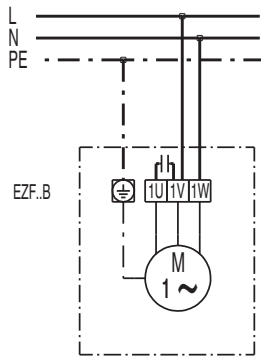

SCHALTBILDER

EZF 50/6 B

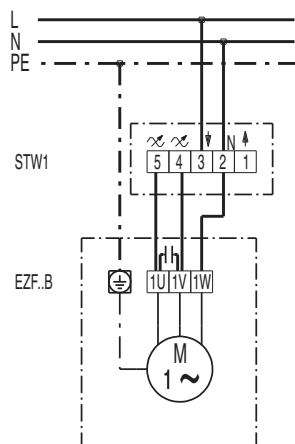
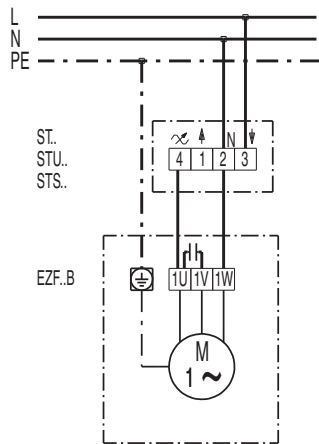

EZF 50/6 B

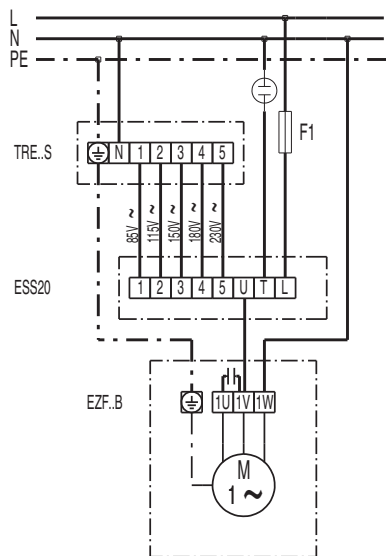
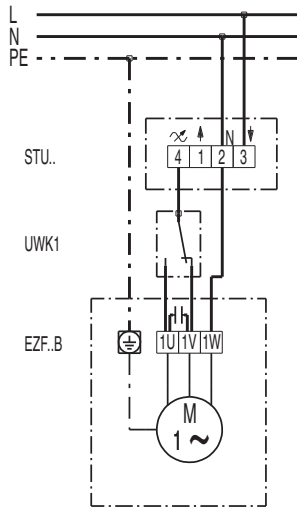

SCHALTBILDER

EZF 50/6 B

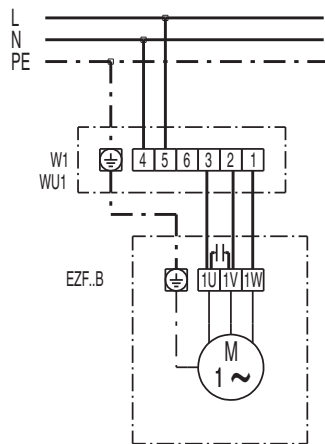
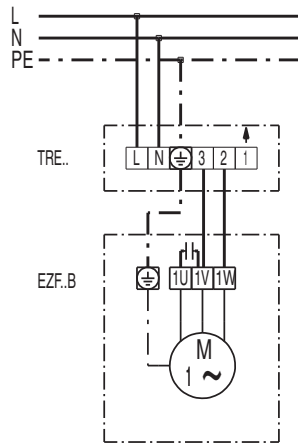

SCHALTBILDER

EZF 50/6 B

