

ADI 63



Short description

Suction nozzle for turbulence-reduced air intake, sheet steel, DN 630

Article number 0073.0234

Technical data

Air direction	Ventilation and air extraction
Material	Sheet steel
Colour	Silver
Weight	9,8 kg
Weight including packaging	9,8 kg
Suitable for nominal size	630 mm
Width	810 mm
Height	810 mm
Depth	190 mm
Width with packaging	810 mm
Height with packaging	810 mm
Depth with packaging	190 mm
Packing unit	1 piece
Range	C
GTIN (EAN)	4012799732341

Dimensioned drawing [mm]

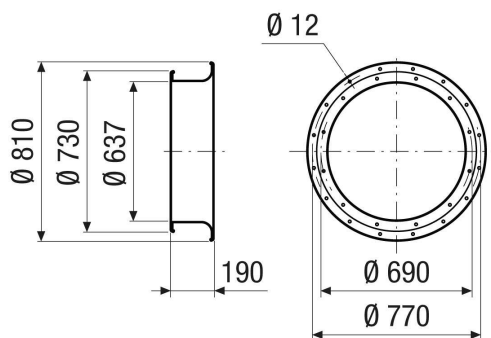



ADI 63