

ASB 80



Short description

90° exhaust socket with O-ring gasket and protective grille for folded spiral-seams ducts, DN 80

Article number 0055.0530

Technical data

Type of installation	Recessed-mounted
Ambient temperature	60 °C
Packing unit	1 piece
Range	K
GTIN (EAN)	4012799555308

Dimensioned drawing [mm]

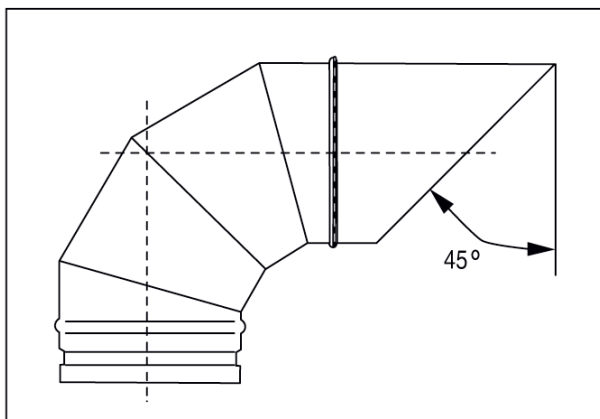

DN
80