

# AVM 10



## Short description

Automatic duct shutter, DN 100

Article number 0093.0002

## Technical data

Air direction	Ventilation or air extraction
Installation position	vertical / horizontal
Material	Sheet steel, galvanised
Weight	0,19 kg
Weight including packaging	0,3 kg
Type of shutter	Airstream-operated opening/closing
Nominal size	100 mm
Width	98 mm
Height	98 mm
Depth	88 mm
Width with packaging	106 mm
Height with packaging	106 mm
Depth with packaging	97 mm
Packing unit	1 piece
Range	C
GTIN (EAN)	4012799930020

# AVM 10

## Characteristic curve Pressure losses

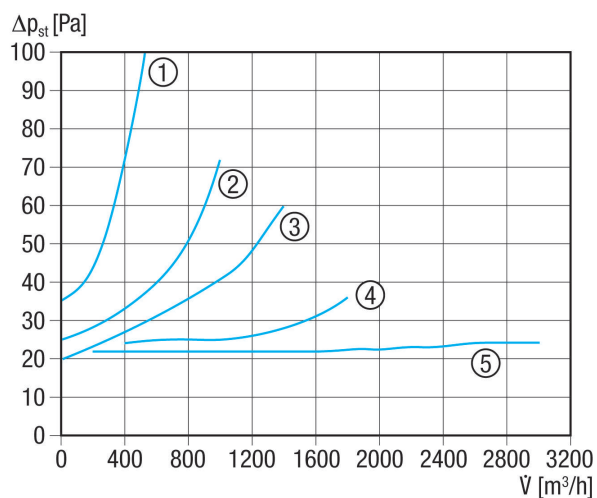

- ① AVM 10
- ② AVM 12
- ③ AVM 15
- ④ AVM 16
- ⑤ AVM 20, AVM 25, AVM 31, AVM 35, AVM 40

## Dimensioned drawing [mm]

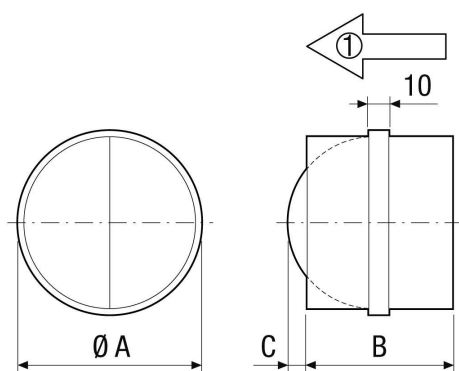

	A	B	C
	100	88	26
① Air flow direction			