

AVM 15



Short description

Automatic duct shutter, DN 150

Article number 0093.0004

Technical data

Air direction	Ventilation or air extraction
Installation position	vertical / horizontal
Material	Sheet steel, galvanised
Weight	0,3 kg
Weight including packaging	0,5 kg
Type of shutter	Airstream-operated opening/closing
Nominal size	150 mm
Width	149 mm
Height	149 mm
Depth	88 mm
Width with packaging	170 mm
Height with packaging	165 mm
Depth with packaging	95 mm
Packing unit	1 piece
Range	C
GTIN (EAN)	4012799930044

AVM 15

Characteristic curve Pressure losses

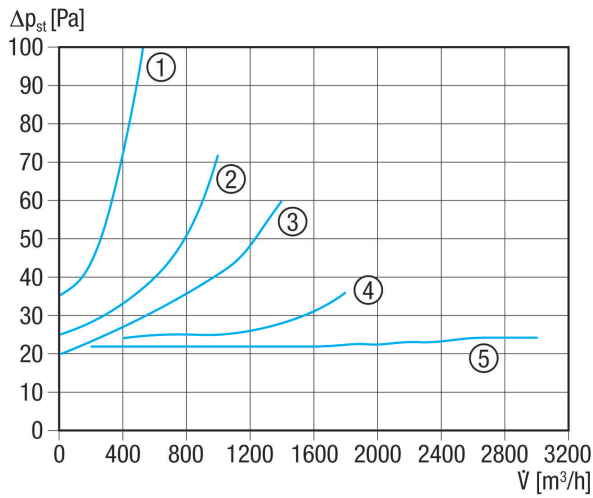

- ① AVM 10
- ② AVM 12
- ③ AVM 15
- ④ AVM 16
- ⑤ AVM 20, AVM 25, AVM 31, AVM 35, AVM 40

Dimensioned drawing [mm]

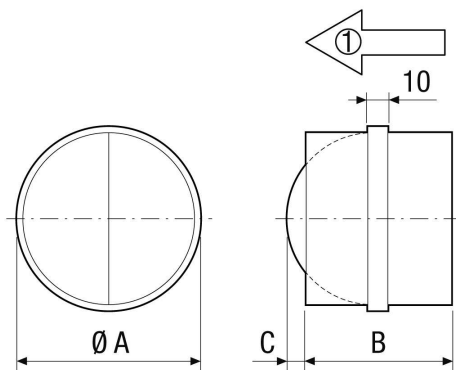

	A	B	C
	150	88	31
① Air flow direction			