

AVM 16



Short description

Automatic duct shutter, DN 160

Article number 0093.0008

Technical data

Air direction	Ventilation or air extraction
Installation position	vertical / horizontal
Material	Sheet steel, galvanised
Weight	0,5 kg
Weight including packaging	0,53 kg
Type of shutter	Airstream-operated opening/closing
Nominal size	160 mm
Width	158 mm
Height	158 mm
Depth	88 mm
Width with packaging	158 mm
Height with packaging	158 mm
Depth with packaging	88 mm
Packing unit	1 piece
Range	C
GTIN (EAN)	4012799930082

AVM 16

Characteristic curve Pressure losses

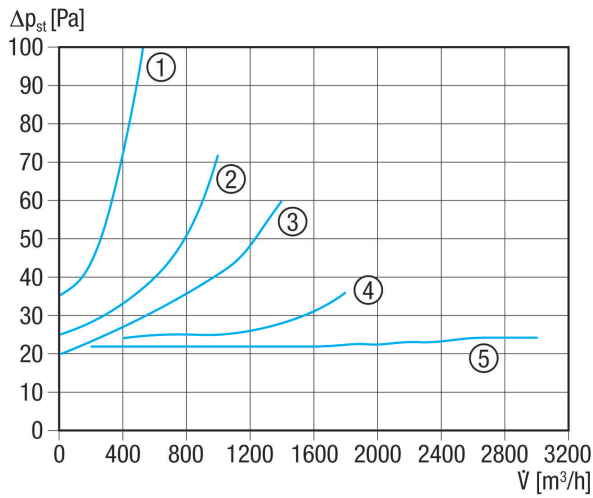

- ① AVM 10
- ② AVM 12
- ③ AVM 15
- ④ AVM 16
- ⑤ AVM 20, AVM 25, AVM 31, AVM 35, AVM 40

Dimensioned drawing [mm]

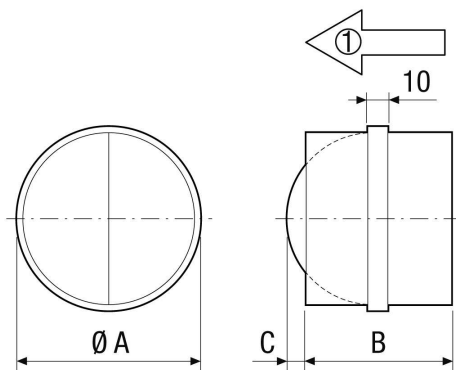

	A	B	C
	160	88	36
① Air flow direction			