

AVM 35



Short description

Automatic duct shutter, DN 355

Article number 0093.0012

Technical data

Air direction	Ventilation or air extraction
Installation position	vertical / horizontal
Material	Sheet steel, galvanised
Weight	2,1 kg
Weight including packaging	2,12 kg
Type of shutter	Airstream-operated opening/closing
Nominal size	355 mm
Width	353 mm
Height	353 mm
Depth	198 mm
Width with packaging	353 mm
Height with packaging	353 mm
Depth with packaging	198 mm
Packing unit	1 piece
Range	C
GTIN (EAN)	4012799930129

AVM 35

Characteristic curve Pressure losses

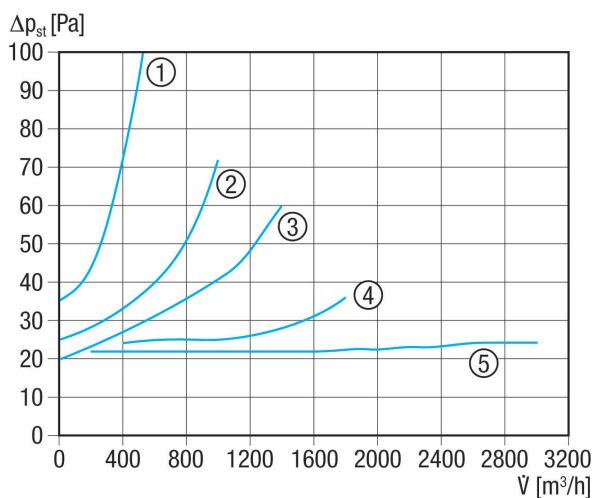

- ① AVM 10
- ② AVM 12
- ③ AVM 15
- ④ AVM 16
- ⑤ AVM 20, AVM 25, AVM 31, AVM 35, AVM 40

Dimensioned drawing [mm]

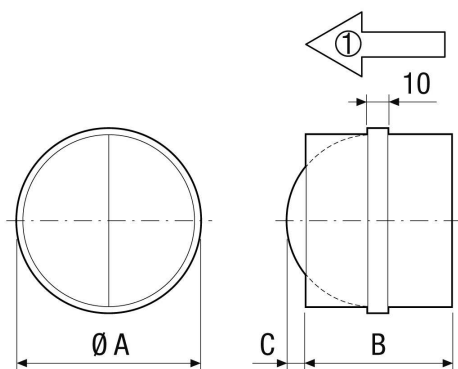

	A	B	C
	355	198	80
① Air flow direction			