

B45-150



Short description

45° elbow, drawn for folded spiral-seams ducts, incl. lip seal, DN 150

Article number

0055.0327

Technical data

Type of installation	Recessed-mounted
Material	Sheet steel
Nominal size	150 mm
Ambient temperature	60 °C
Packing unit	1 piece
Range	K
GTIN (EAN)	4012799553274

Dimensioned drawing [mm]

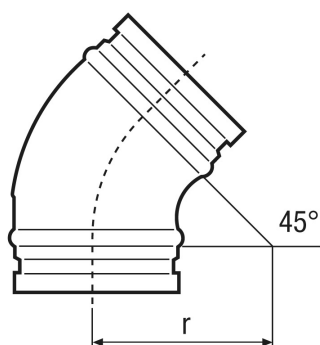

DN	150
DN = R	