

B45-180



Short description

45° elbow, drawn for folded spiral-seams ducts, incl. lip seal, DN 180

Article number 0055.0329

Technical data

Type of installation	Recessed-mounted
Material	Sheet steel
Nominal size	180 mm
Ambient temperature	60 °C
Packing unit	1 piece
Range	K
GTIN (EAN)	4012799553298

Dimensioned drawing [mm]

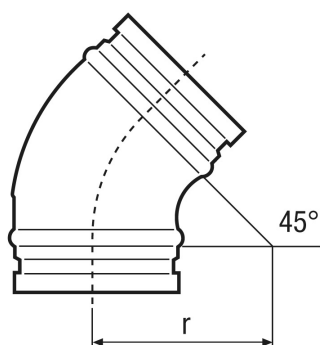

DN	180
DN = R	