

B45-200



Short description

45° elbow, drawn for folded spiral-seams ducts, incl. lip seal, DN 200

Article number 0055.0330

Technical data

Type of installation	Recessed-mounted
Material	Sheet steel
Nominal size	200 mm
Ambient temperature	60 °C
Packing unit	1 piece
Range	K
GTIN (EAN)	4012799553304

Dimensioned drawing [mm]

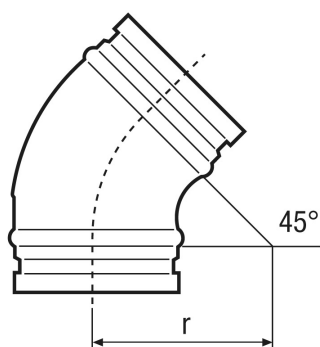

DN

 200

DN = R