

# DRD 22 EC

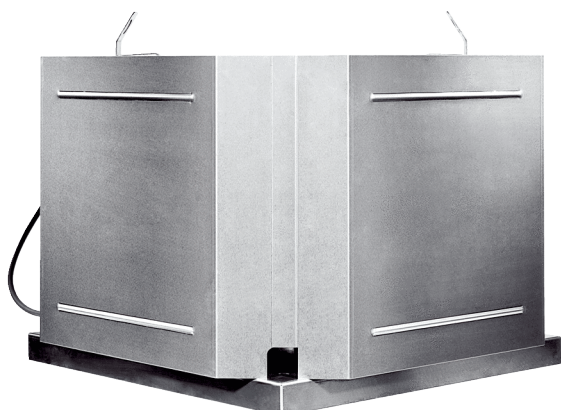

## Short description

Centrifugal roof fan with EC motor, DN 224

## Application examples

Production facility, Workplace, Commercial premises, Industrial building, Restaurant

Article number 0087.0171

## Technical data

Air flow volume	2.125 m³/h
Rotating speed	1.840 1/min
Impeller type	radial
Speed controllable	✓
Reversing capacity	–
Type of voltage	Alternating current
Rated voltage	230 V
Frequency	50 Hz
Nominal output	165 W
I <sub>max</sub>	1,3 A
Degree of protection	IP 54
Installation site	Roof
Installation position	vertical
Material	Aluminium
Weight	9,3 kg
Weight including packaging	14,5 kg
Nominal size	224 mm
Width	520 mm
Height	331 mm
Depth	520 mm
Width with packaging	710 mm
Height with packaging	490 mm
Depth with packaging	710 mm
Airstream temperature at I <sub>Max</sub>	-25 °C up to 60 °C
Packing unit	1 piece
Range	E
GTIN (EAN)	4012799871712

# DRD 22 EC

## Sound power level in octave range

	63 Hz	125 Hz	250 Hz	500 Hz	1 kHz	2 kHz	4 kHz	8 kHz	Total
$L_{WA5, high}$ (dB(A))	-	-	-	-	-	-	-	-	73
$L_{WA6, high}$ (dB(A))	-	-	-	-	-	-	-	-	77

$L_{WA5}$ = free inlet sound power level in dB.  
 $L_{WA6}$ = free outlet sound power level in dB.

## Characteristic curve

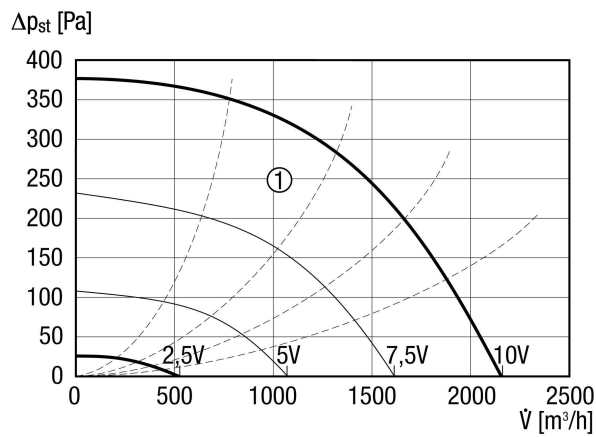

① Auxiliary characteristics curves for control voltage 2.5 - 10 V

# DRD 22 EC

Dimensioned drawing [mm]

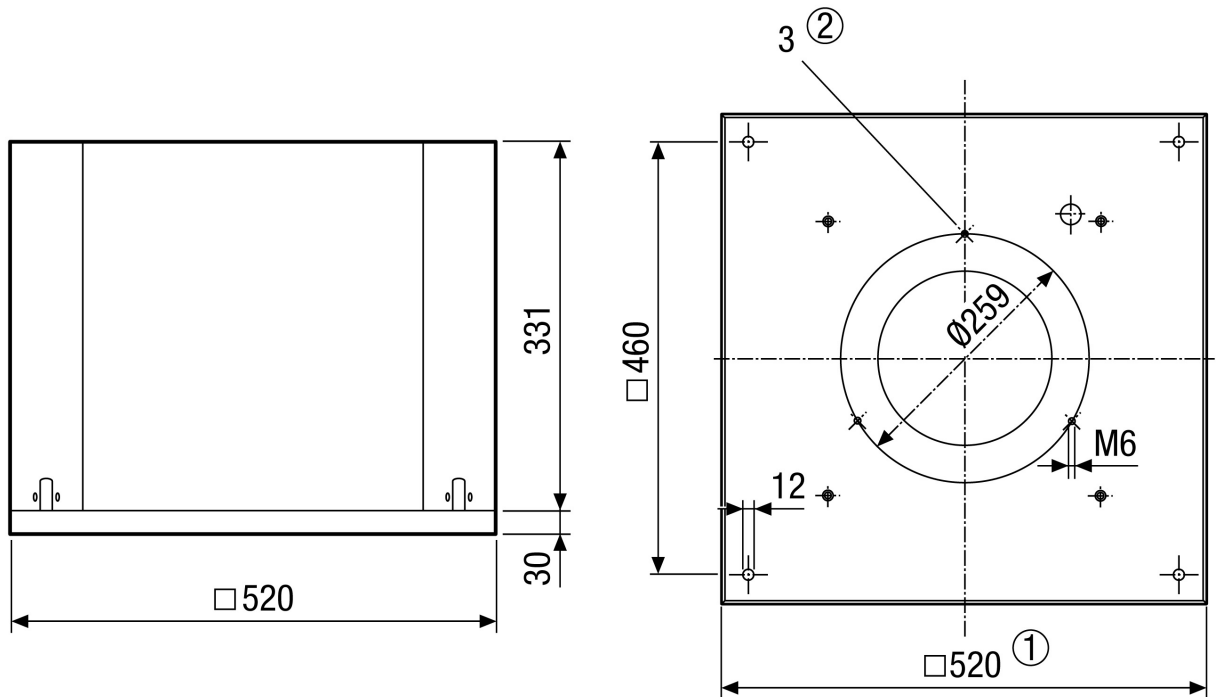

- ① Clear width
- ② Number of holes: 3