

DRH 31-12 R



Short description

Electric air heater with integrated temperature controller, DN 315, three-phase AC

Article number 0082.0146

Technical data

Minimum air flow volume	410 m ³ /h
Type of voltage	Three-phase AC
Rated voltage	400 V
Frequency	50 Hz
I _{max}	10 A
Degree of protection	IP 43
Installation	inside and outside
Installation position	horizontal / vertical
Housing material	Sheet steel, galvanised
Weight	8,25 kg
Weight including packaging	8,95 kg
Nominal size	315 mm
Width	315 mm
Height	396 mm
Depth	375 mm
Width with packaging	385 mm
Height with packaging	460 mm
Depth with packaging	385 mm
Air heater type	electrical
Heater power rating	12.000 W
Packing unit	1 piece
Range	C
GTIN (EAN)	4012799821465

DRH 31-12 R

Characteristic curve Pressure losses

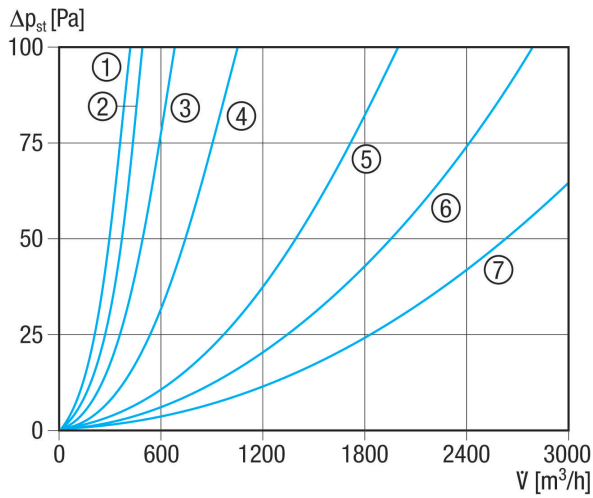

- ① ERH 16-2 R
- ② DRH 16-5 R
- ③ DRH 20-6 R
- ④ DRH 25-9 R
- ⑤ DRH 31-12 R
- ⑥ DRH 35-12 R
- ⑦ DRH 40-12 R

Characteristic curve Increase in temperature

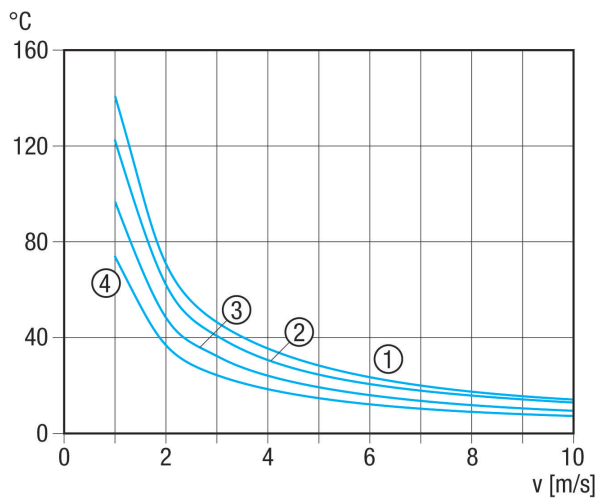

- ① DRH 25-9 R
- ② DRH 31-12 R
- ③ DRH 35-12 R
- ④ DRH 40-12 R

DRH 31-12 R

Characteristic curve Increase in temperature

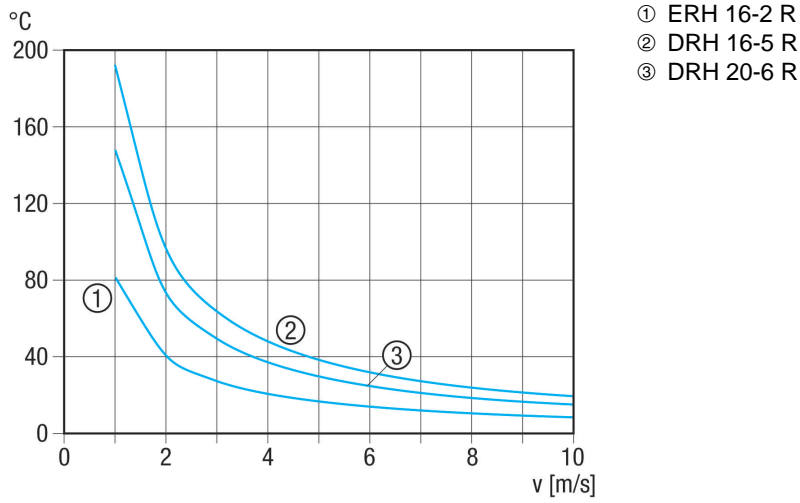

Dimensioned drawing [mm]

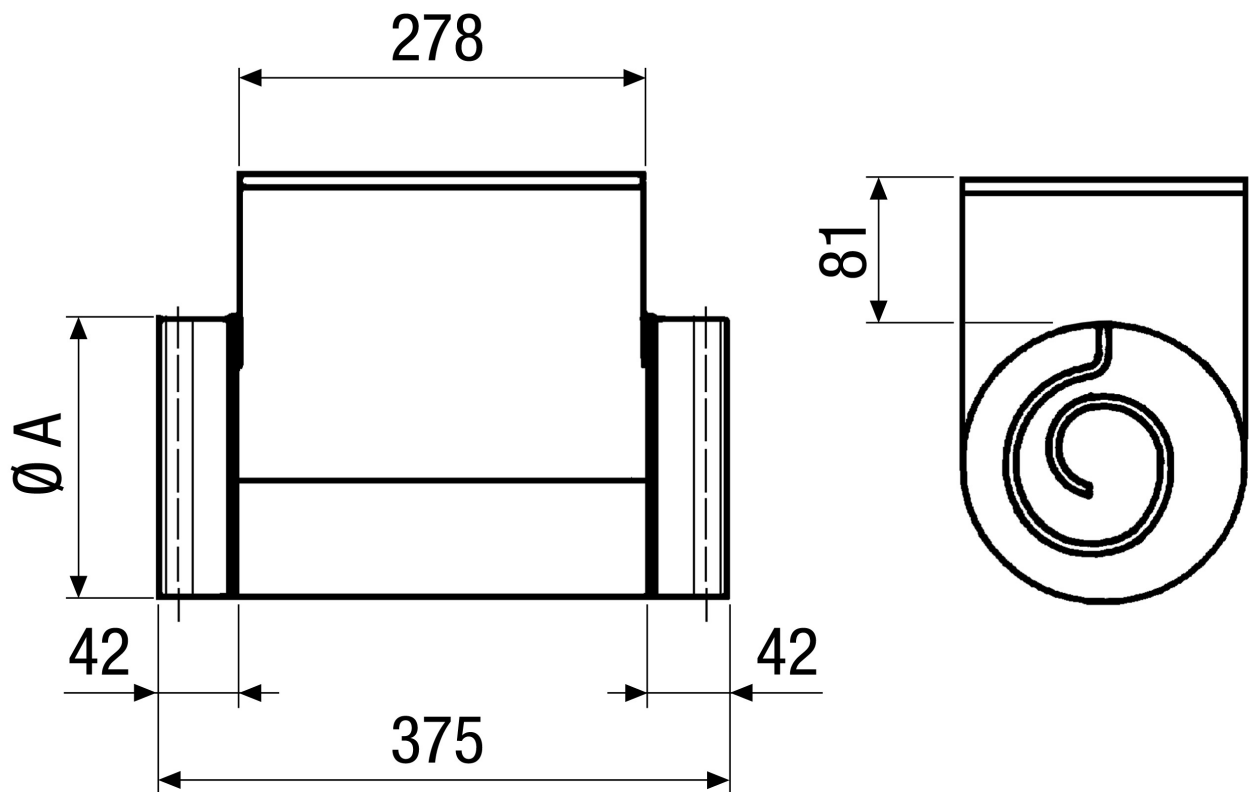

A
315



DRH 31-12 R

DRH 35-12 R: No rubber seal on the connection couplings