

# DZF 35/6 B

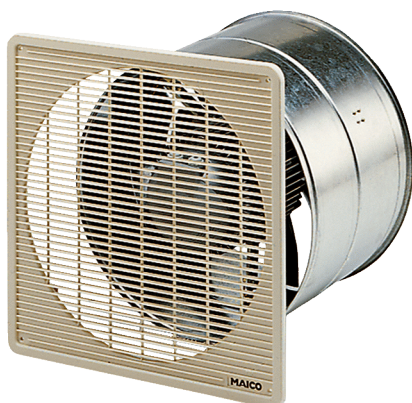

## Short description

Axial wall fan for recessed-mounted installation, DN 350, three-phase AC

## Application examples

Changing room, Foreman's office, Restaurant, Garage, Fitness room

Article number 0085.0103

## Technical data

Model	Wall sleeve
Air flow volume	1.600 m <sup>3</sup> /h
Rotating speed	930 1/min
Impeller type	axial
Speed controllable	✓
Reversing capacity	✓
Type of voltage	Three-phase AC
Rated voltage	400 V
Frequency	50 Hz
Nominal output	80 W
Power consumption	85 W
I <sub>nom</sub>	0,17 A
I <sub>max</sub>	0,18 A
Degree of protection	IP 55
Insulation class	B
Mains cable	7 x 1,5 mm <sup>2</sup>
Installation site	Wall / Ceiling
Type of installation	Recessed-mounted
Installation position	horizontal / vertical
Material	Sheet steel, galvanised
Colour	Silver
Weight	7,13 kg
Weight including packaging	8,54 kg
Nominal size	350 mm
Width	428 mm
Height	428 mm
Depth	300 mm
Width with packaging	440 mm
Height with packaging	440 mm

# DZF 35/6 B

Depth with packaging	345 mm
Airstream temperature at nominal current	60 °C
Airstream temperature at I <sub>Max</sub>	-20 °C up to 60 °C
Packing unit	1 piece
Range	C
GTIN (EAN)	4012799851035

## Sound power level in octave range

	63 Hz	125 Hz	250 Hz	500 Hz	1 kHz	2 kHz	4 kHz	8 kHz	Total
<b>L<sub>WA7, S5</sub></b> <b>(dB(A))</b>	29	48	56	59	55	55	48	35	63

L<sub>WA7</sub>= housing and free inlet sound power level in dB.

## Characteristic curve

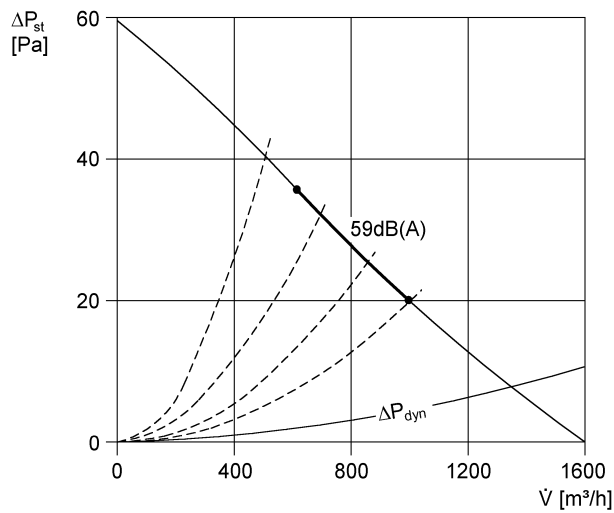

# DZF 35/6 B

Dimensioned drawing [mm]

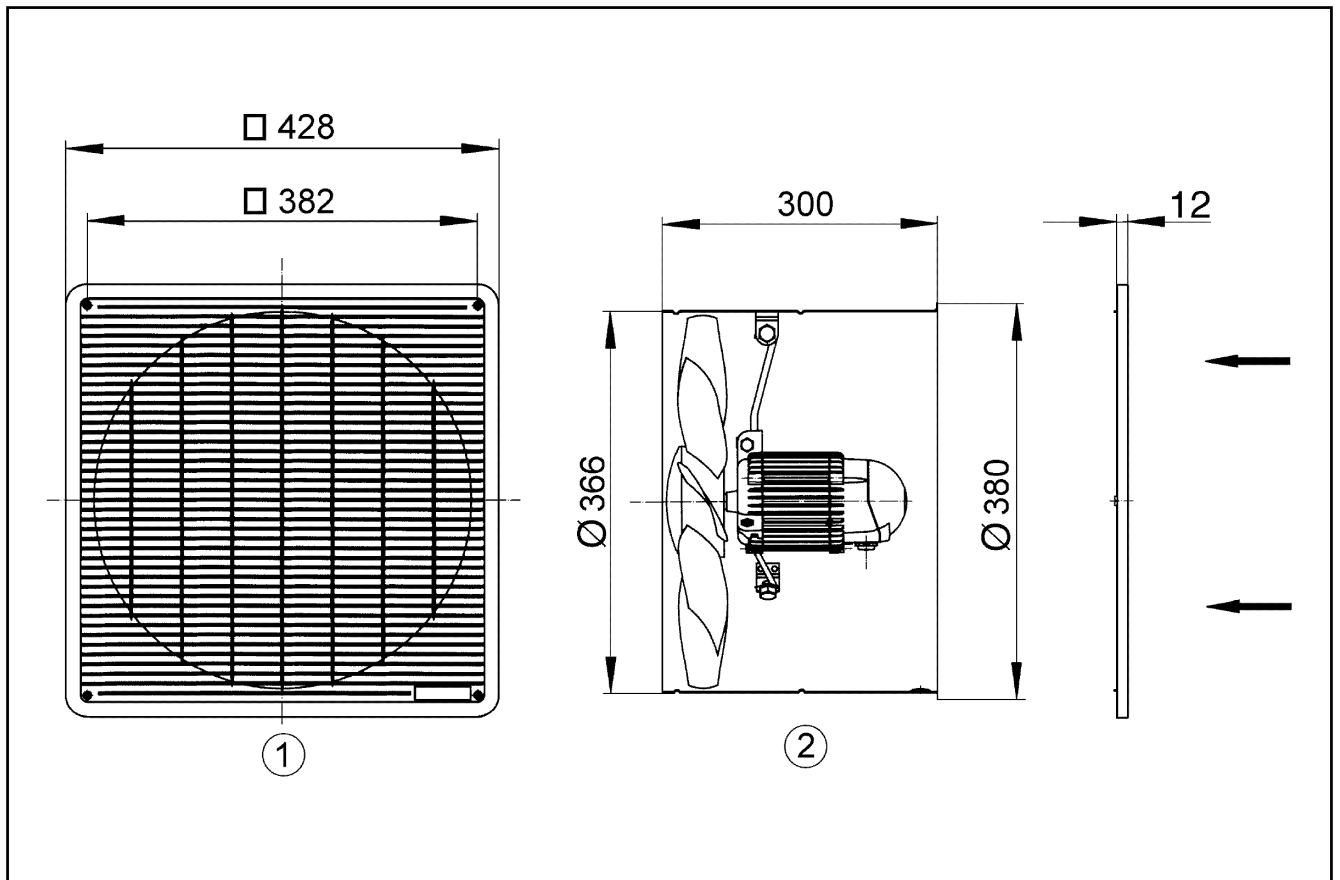

- ① Protective grille on intake side
- ② Air flow direction with air drawn across the motor