

# DZR 20/2 B



## Short description

Axial duct fan, DN 200, three-phase AC

## Application examples

Machine extraction unit, Showroom, Foreman's office, Workshop, Production site

Article number 0086.0020

## Technical data

Air flow volume	1.100 m³/h
Rotating speed	2.850 1/min
Impeller type	axial
Speed controllable	✓
Reversing capacity	✓
Type of voltage	Three-phase AC
Rated voltage	400 V
Frequency	50 Hz
Nominal output	75 W
I <sub>nom</sub>	0,2 A
I <sub>max</sub>	0,25 A
Degree of protection	IP 55
Insulation class	B
Pole-changeable	–
Mains cable	7 x 1,5 mm²
Installation position	horizontal / vertical
Material	Sheet steel, galvanised
Colour	Silver
Weight	5,96 kg
Weight including packaging	6,55 kg
Nominal size	200 mm
Width	254 mm
Height	317 mm
Depth	240 mm
Width with packaging	355 mm
Height with packaging	335 mm
Depth with packaging	265 mm
Airstream temperature at nominal current	-20 °C up to 60 °C
Airstream temperature at I <sub>Max</sub>	-20 °C up to 60 °C

# DZR 20/2 B

Packing unit	1 piece
Range	C
GTIN (EAN)	4012799860204

## Sound power level in octave range

	63 Hz	125 Hz	250 Hz	500 Hz	1 kHz	2 kHz	4 kHz	8 kHz	Total
<b>L<sub>WA2</sub>, S1</b> <b>(dB(A))</b>	12	32	35	36	40	36	31	29	44
<b>L<sub>WA2</sub>, S2</b> <b>(dB(A))</b>	20	34	49	45	53	49	44	39	56
<b>L<sub>WA2</sub>, S3</b> <b>(dB(A))</b>	22	38	50	50	55	53	48	43	59
<b>L<sub>WA2</sub>, S4</b> <b>(dB(A))</b>	27	39	51	52	58	56	51	45	62
<b>L<sub>WA2</sub>, S5</b> <b>(dB(A))</b>	26	40	55	54	59	57	52	46	63
<b>L<sub>WA5</sub>, S1</b> <b>(dB(A))</b>	18	31	43	50	45	46	41	30	53
<b>L<sub>WA5</sub>, S2</b> <b>(dB(A))</b>	26	38	55	60	59	61	58	47	66
<b>L<sub>WA5</sub>, S3</b> <b>(dB(A))</b>	29	40	61	63	63	64	62	52	70
<b>L<sub>WA5</sub>, S4</b> <b>(dB(A))</b>	38	42	58	70	66	67	64	55	74
<b>L<sub>WA5</sub>, S5</b> <b>(dB(A))</b>	33	43	59	71	67	68	65	56	75
<b>L<sub>WA6</sub>, S1</b> <b>(dB(A))</b>	23	35	40	51	50	50	43	31	56
<b>L<sub>WA6</sub>, S2</b> <b>(dB(A))</b>	29	41	53	63	65	64	60	49	69
<b>L<sub>WA6</sub>, S3</b> <b>(dB(A))</b>	32	44	55	68	69	69	64	55	74
<b>L<sub>WA6</sub>, S4</b> <b>(dB(A))</b>	35	44	53	70	72	71	67	60	77
<b>L<sub>WA6</sub>, S5</b> <b>(dB(A))</b>	35	46	56	73	73	68	68	60	78

L<sub>WA2</sub>= housing sound power level in dB.

L<sub>WA5</sub>= free inlet sound power level in dB.

L<sub>WA6</sub>= free outlet sound power level in dB.

# DZR 20/2 B

## Characteristic curve

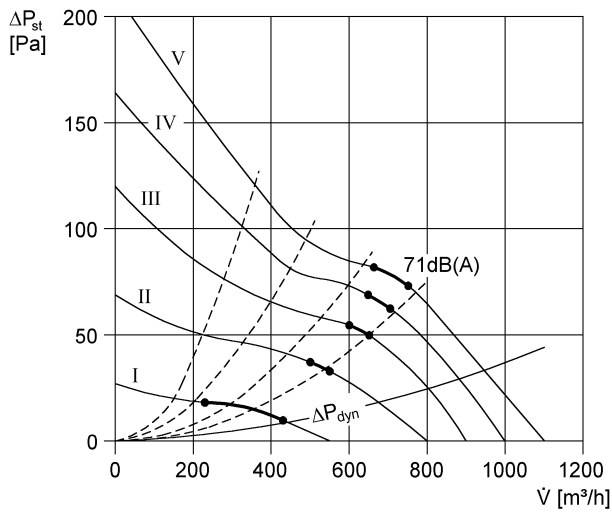

## Dimensioned drawing [mm]

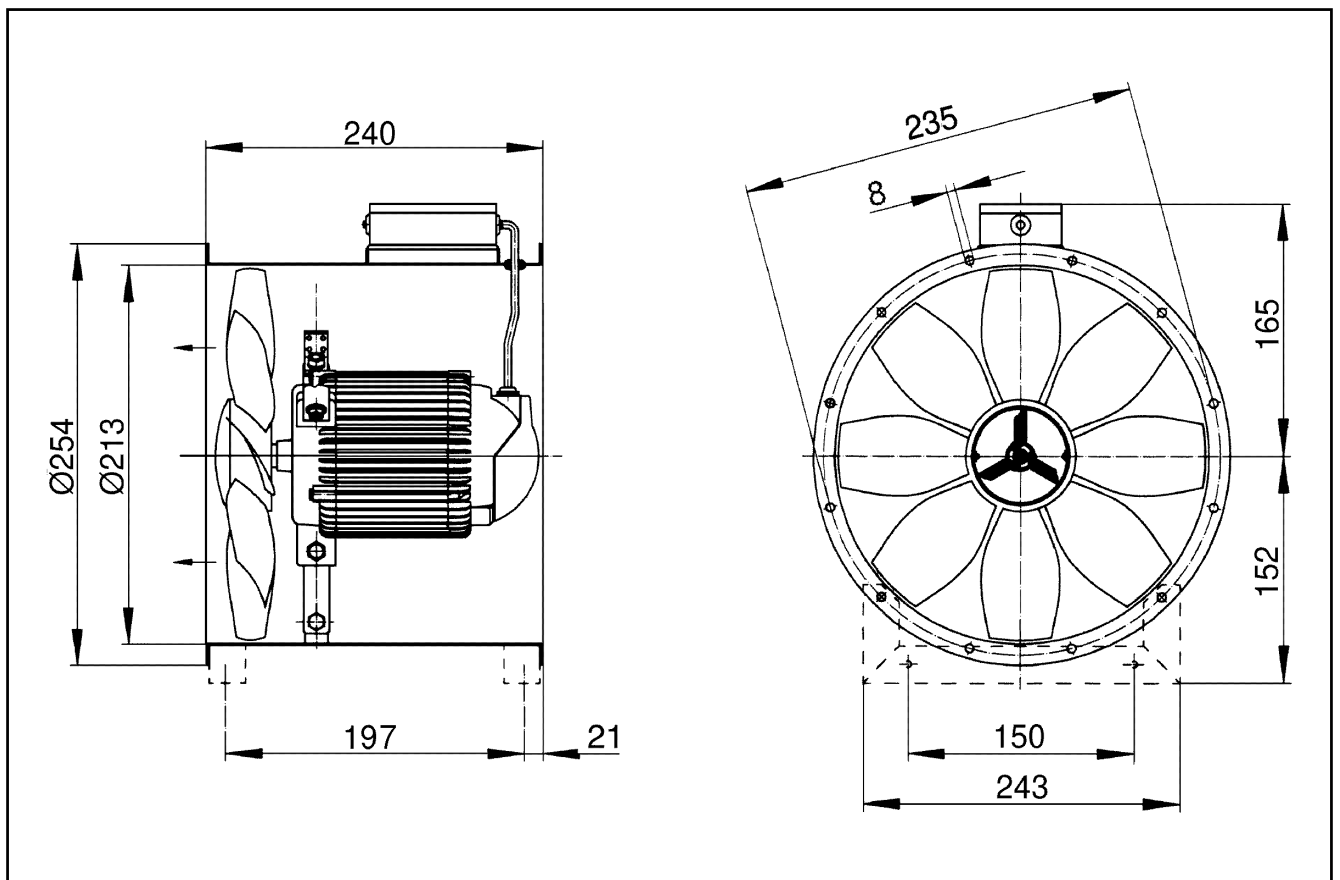

Number of flange holes: 6