

DZR 25/2 B Ex t



Short description

Axial duct fan, DN250, three-phase AC, explosion-proof, medium: dust

Article number 0086.0722

Technical data

Air flow volume	1.950 m ³ /h
Speed controllable	✓
Reversing capacity	✓
Type of voltage	Three-phase AC
Rated voltage	400 V
Frequency	50 Hz
Nominal output	130 W
cosφ	0,65
I _{nom}	0,28 A
I _{max} at U _{Nominal}	0,4 A
Degree of protection	IP 64
Insulation class	F
Material	Sheet steel, galvanised
Colour	galvanised
Weight	8,6 kg
Weight including packaging	9,51 kg
Nominal size	250 mm
Width	372 mm
Height	372 mm
Depth	300 mm
Width with packaging	420 mm
Height with packaging	430 mm
Depth with packaging	330 mm
EX designation in accordance with the ATEX Directive	Ex II 2 D
EX designation in accordance with standard	Ex tb IIIB T135°C Db IP64 X / Ex h IIIB T135°C Db X
Ta ambient temperature	-20 °C ≤ Ta ≤ +40 °C
Time t _A	69 sek
Operating mode	S1
PTC DIN 44082	M 100

DZR 25/2 B Ex t

EC type examination certificate	TÜV-A 19 ATEX0103 X, IECEx EPS 19.0019X
Temperature class	T135°C
Temperature class of insulating materials Th. Cl.	155 (F)
Packing unit	1 piece
Range	C
GTIN (EAN)	4012799867227

Sound power level in octave range

	63 Hz	125 Hz	250 Hz	500 Hz	1 kHz	2 kHz	4 kHz	8 kHz	Total
L_{WA5} (dB)	-	-	-	-	-	-	-	-	81

L_{WA5}= free inlet sound power level in dB.

Characteristic curve

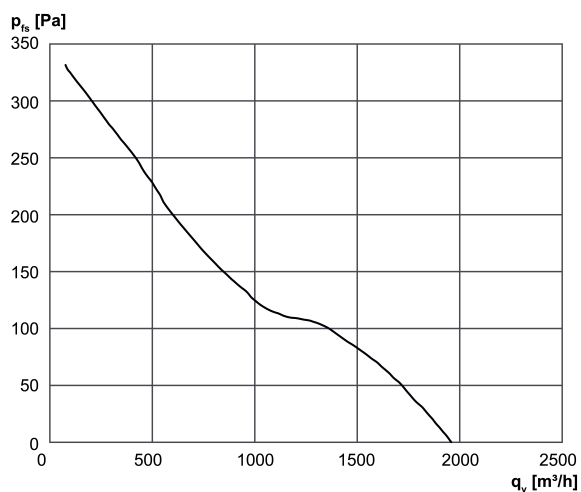

DZR 25/2 B Ex t

Dimensioned drawing [mm]

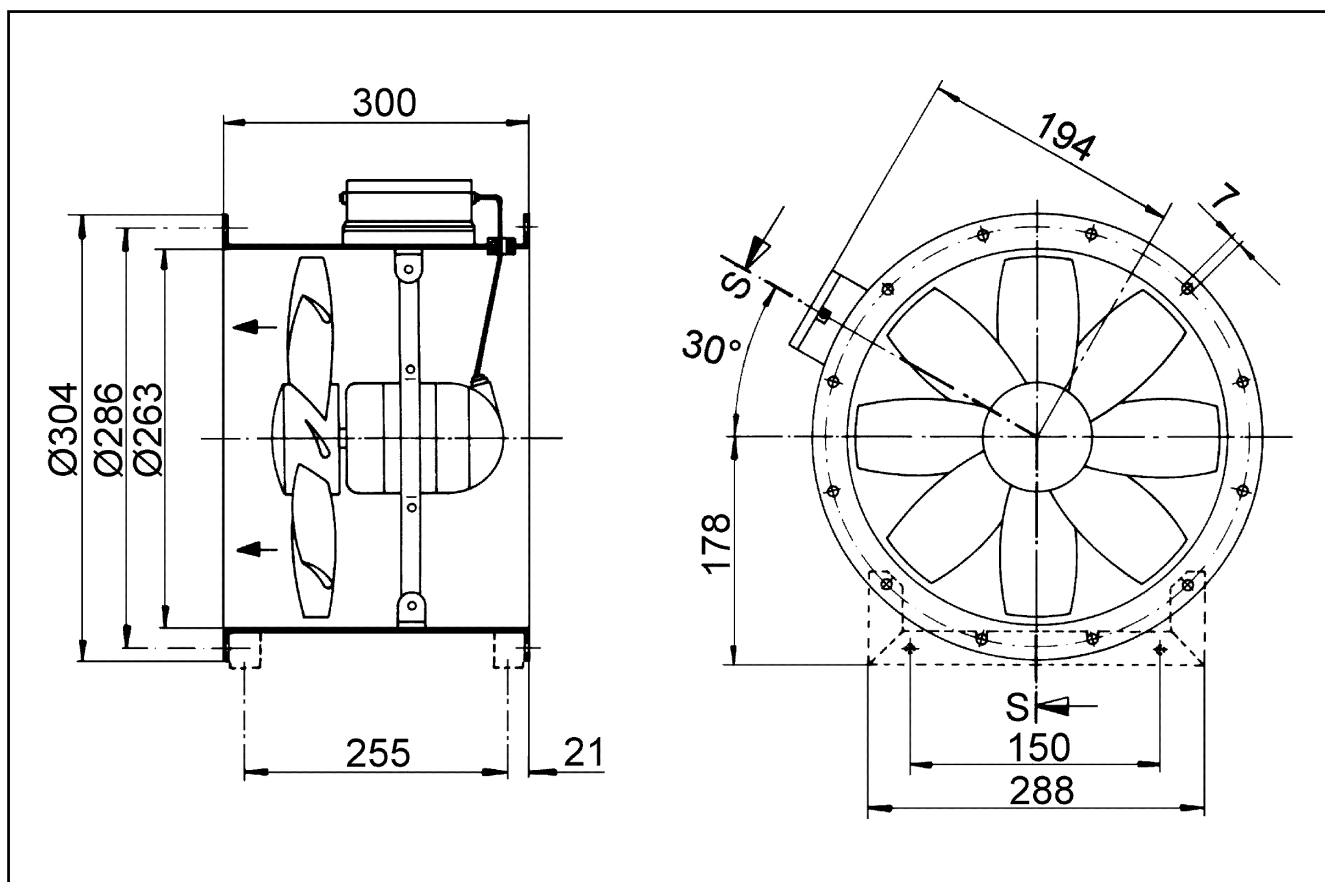

Number of flange holes: 6