

DZR 35/4 B Ex e



Short description

Axial duct fan, DN350, three-phase AC, explosion-proof, medium: gas

Application examples

Environment with explosion hazard (zone 1 and 2), Workshop, Storage facility, Laboratory, Workplace air extraction system

Article number 0086.0707

Technical data

Air flow volume	2.650 m ³ /h
Rotating speed	1.455 1/min
Impeller type	axial
Speed controllable	✓
Reversing capacity	✓
Type of voltage	Three-phase AC
Rated voltage	400 V
Frequency	50 Hz
Nominal output	125 W
cosφ	0,36
I _{nom}	0,49 A
I _{max} at U _{Nominal}	0,5 A
Degree of protection	IP 64
Insulation class	F
Installation position	vertical / horizontal
Material	Sheet steel, galvanised
Housing material	Sheet steel, galvanised
Colour	galvanised
Weight	10,6 kg
Weight including packaging	12,35 kg
Nominal size	350 mm
Width	474 mm
Height	474 mm
Depth	320 mm
Width with packaging	475 mm
Height with packaging	480 mm
Depth with packaging	355 mm
EX designation in accordance with the ATEX Directive	Ex II 2 G
EX designation in accordance with standard	Ex eb IIB + H ₂ T3 Gb / Ex h IIB + H ₂ T3 Gb

DZR 35/4 B Ex e

Ta ambient temperature	-20 °C ≤ Ta ≤ +60 °C
I _A /I _N	3,4
Time t _A	170 sek
Operating mode	S1
PTC DIN 44082	M 130
EC type examination certificate	TÜV-A 19 ATEX0103 X, IECEx EPS 19.0019X
Temperature class	T3
Temperature class of insulating materials Th. Cl.	155 (F)
Packing unit	1 piece
Range	C
GTIN (EAN)	4012799867074

Sound power level in octave range

	63 Hz	125 Hz	250 Hz	500 Hz	1 kHz	2 kHz	4 kHz	8 kHz	Total
L _{WA5, high} (dB(A))	-	-	-	-	-	-	-	-	72

L_{WA5}= free inlet sound power level in dB.

Characteristic curve

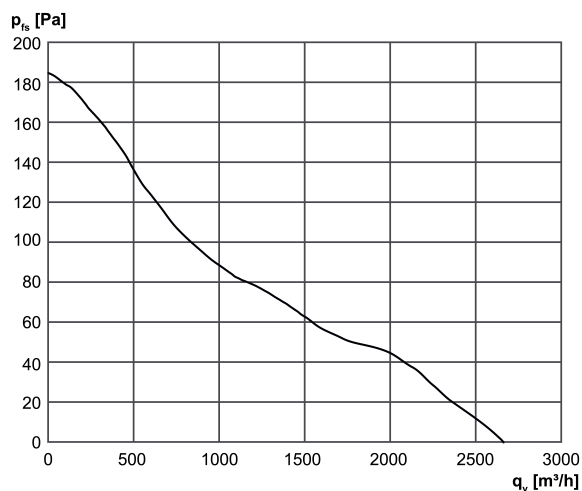

DZR 35/4 B Ex e

Dimensioned drawing [mm]

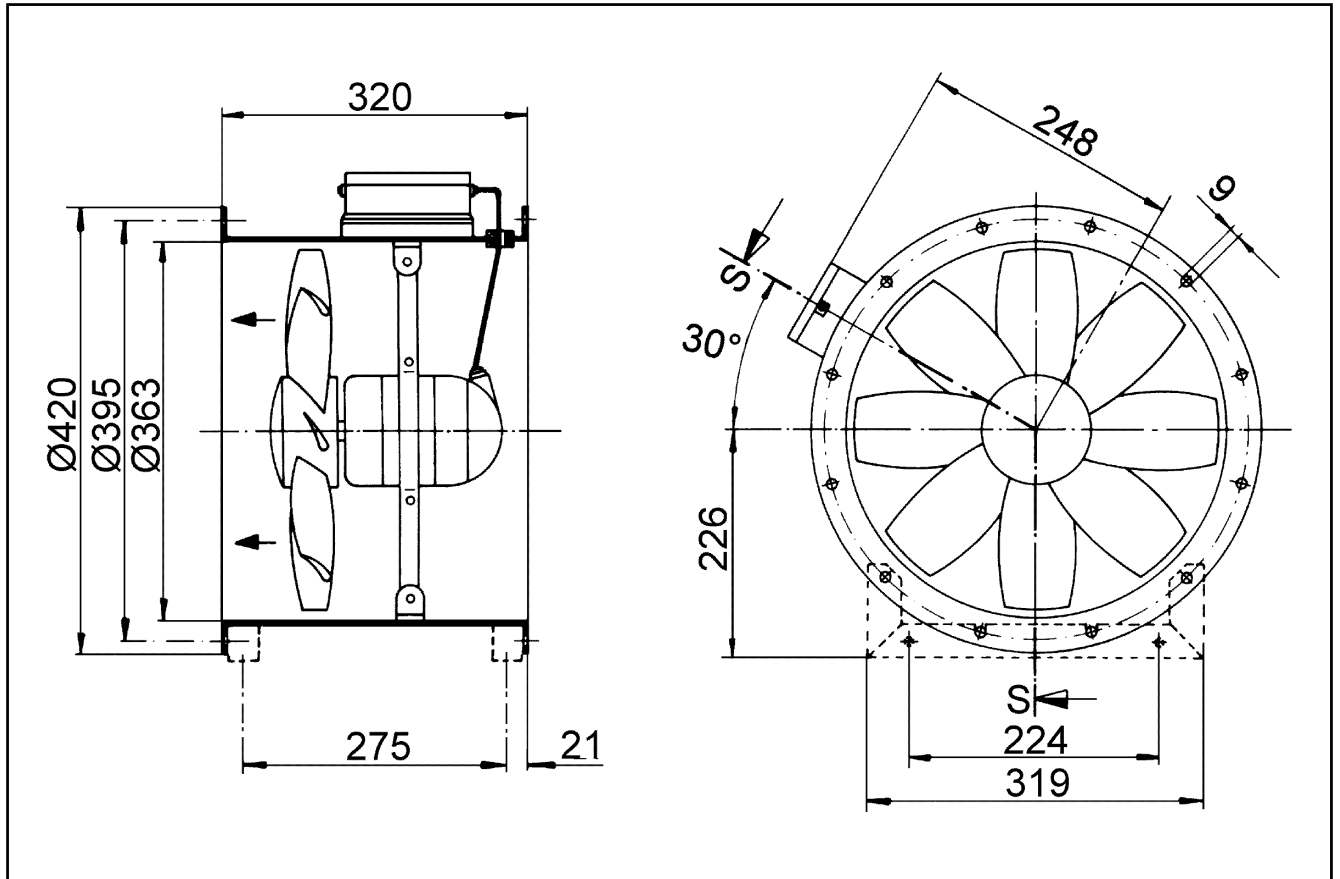

Number of flange holes: 8