

EFG 20 E



Short description

Greenhouse fan, DN 200, AC

Article number 0081.0401

Technical data

Air flow volume	330 m ³ /h
Rotating speed	1.400 1/min
Reversing capacity	–
Nominal output	30 W
Power consumption	33 W
I _{nom}	0,24 A
I _{max}	0,24 A
Degree of protection	IP X4
Weight	4,81
Nominal size	200 mm
Airstream temperature at nominal current	60 °C
Packing unit	1 piece
Range	C
GTIN (EAN)	4012799814016

Sound power level in octave range

	63 Hz	125 Hz	250 Hz	500 Hz	1 kHz	2 kHz	4 kHz	8 kHz	Total
L _{WA1, high} (dB(A))	–	–	–	–	–	–	–	–	55

L_{WA1} = Total sound power level of greenhouse fans or air purifiers, free-suction and free-blowing

EFG 20 E

Dimensioned drawing [mm]

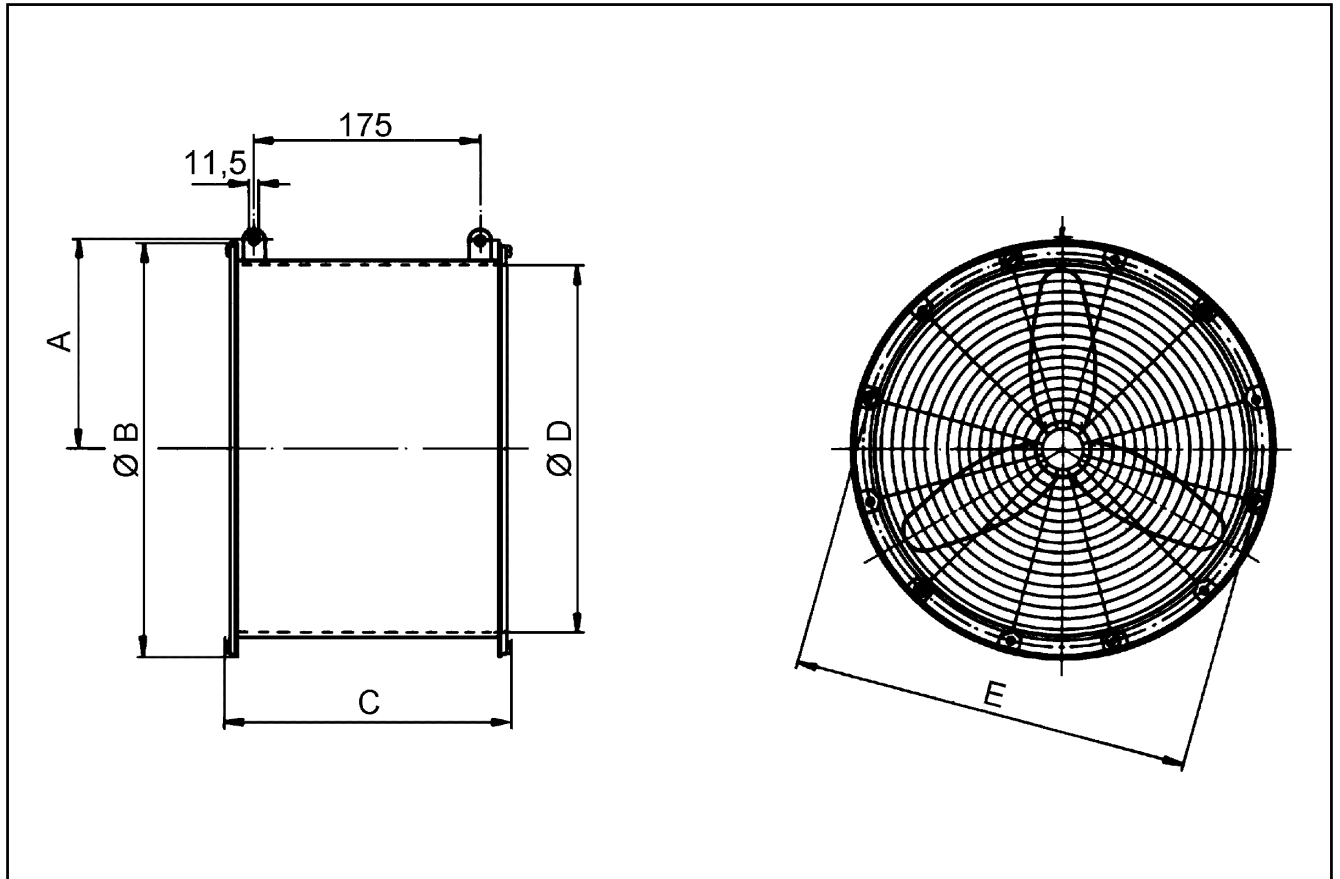

A	B	C	D	E
132	254	240	213	235