

ELM 14 Ex



Short description

Flexible cuff with 2 tensioning straps, DN 140, suitable for use in areas subject to explosion hazards

Article number 0092.0246

Technical data

Material	Synthetic material, antistatic
Colour	Silver grey
Weight	0,08 kg
Weight including packaging	0,1 kg
Suitable for nominal size	140 mm
Width	140 mm
Height	140 mm
Depth	110 mm
Width with packaging	240 mm
Height with packaging	30 mm
Depth with packaging	115 mm
Ambient temperature	50 °C
Ex version	antistatic
Packing unit	1 piece
Range	C
GTIN (EAN)	4012799922469

ELM 14 Ex

Dimensioned drawing [mm]

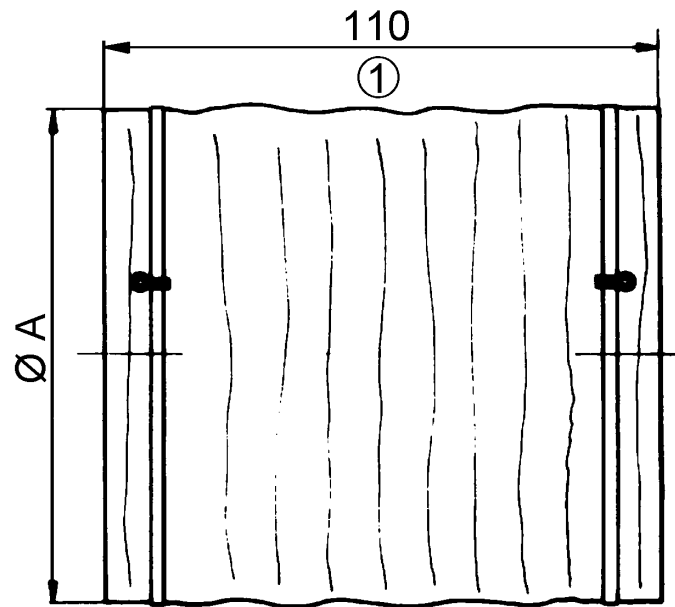

A

140

① Extended length