

# ELM 18



## Short description

Flexible cuff for sound and vibration damped assembly of ERM duct fans, DN 180

Article number 0092.0158

## Technical data

Material	Synthetic material
Colour	Black
Weight	0,1 kg
Weight including packaging	0,1 kg
Suitable for nominal size	180 mm
Width	180 mm
Height	180 mm
Depth	110 mm
Width with packaging	210 mm
Height with packaging	30 mm
Depth with packaging	115 mm
Ambient temperature	50 °C
Packing unit	1 piece
Range	C
GTIN (EAN)	4012799921585

# ELM 18

Dimensioned drawing [mm]

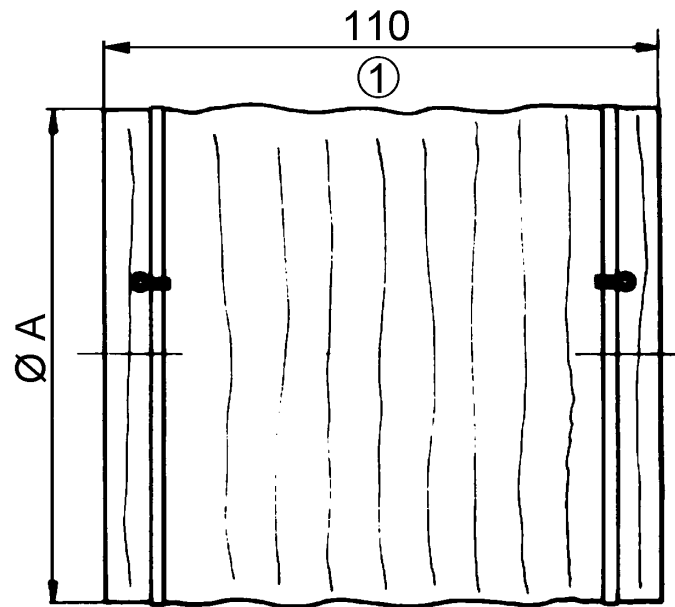

A

180

① Extended length