

ELM 20



Short description

Flexible cuff for sound and vibration damped assembly of ERM duct fans, DN 200

Article number 0092.0118

Technical data

Material	Synthetic material
Colour	Silver grey
Weight	0,1 kg
Weight including packaging	0,11 kg
Suitable for nominal size	200 mm
Width	200 mm
Height	200 mm
Depth	110 mm
Width with packaging	110 mm
Height with packaging	30 mm
Depth with packaging	230 mm
Ambient temperature	50 °C
Packing unit	1 piece
Range	C
GTIN (EAN)	4012799921189

ELM 20

Dimensioned drawing [mm]

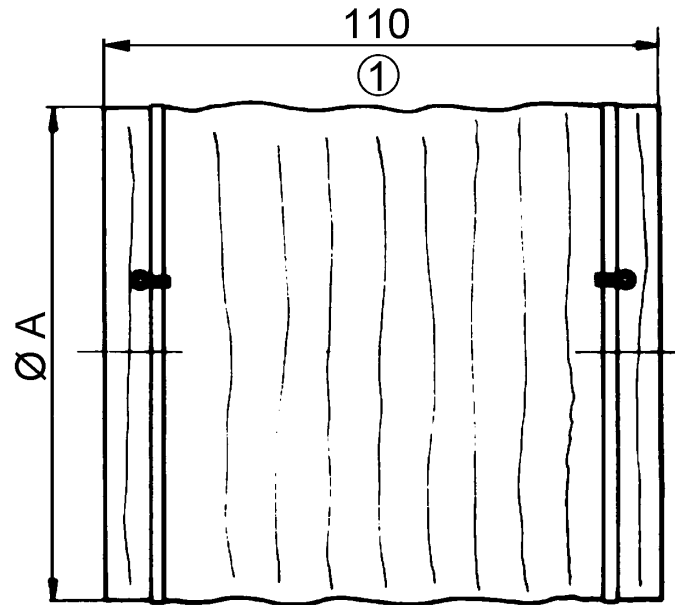

A
200

① Extended length