

ELM 25



Short description

Flexible cuff for sound and vibration damped assembly of ERM duct fans, DN 250

Article number 0092.0119

Technical data

Material	Synthetic material
Colour	Silver grey
Weight	0,1 kg
Weight including packaging	0,13 kg
Suitable for nominal size	250 mm
Width	250 mm
Height	250 mm
Depth	110 mm
Width with packaging	115 mm
Height with packaging	40 mm
Depth with packaging	210 mm
Ambient temperature	50 °C
Packing unit	1 piece
Range	C
GTIN (EAN)	4012799921196

ELM 25

Dimensioned drawing [mm]

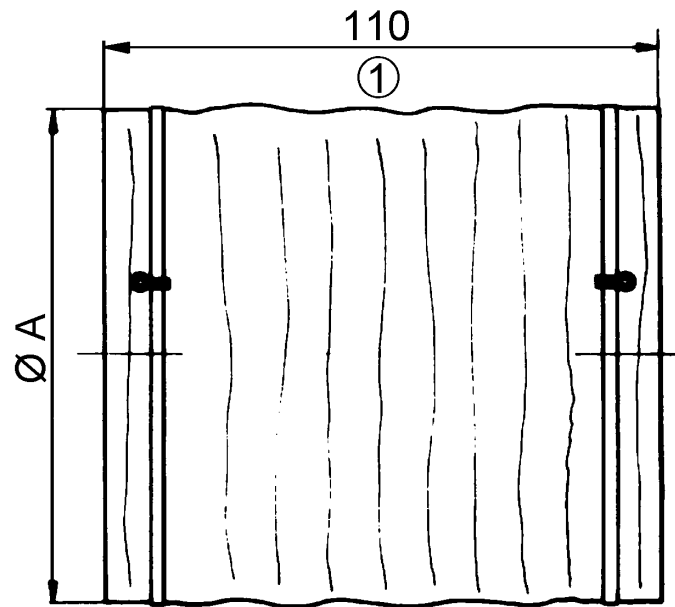

A
250

① Extended length