

ELR 16



Short description

Fixing cuffs for sound and vibration dampening of duct fans, DN 160

Article number 0092.0111

Technical data

Material	Sheet steel, galvanised
Weight	0,2 kg
Weight including packaging	0,22 kg
Suitable for nominal size	160 mm
Width	182 mm
Height	182 mm
Depth	60 mm
Width with packaging	182 mm
Height with packaging	182 mm
Depth with packaging	60 mm
Packing unit	1 piece
Range	C
GTIN (EAN)	4012799921110

Dimensioned drawing [mm]

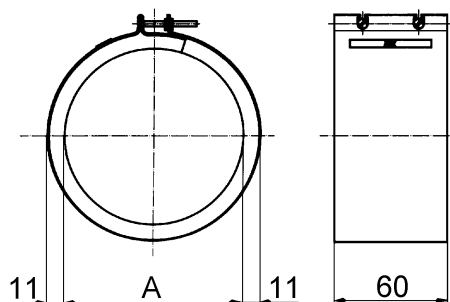

A

160

Shown in installed state. Supplied in elongated form.