

ELR 20



Short description

Fixing cuffs for sound and vibration dampening of duct fans, DN 200

Article number 0092.0112

Technical data

Material	Sheet steel, galvanised
Weight	0,27 kg
Weight including packaging	0,3 kg
Suitable for nominal size	200 mm
Width	222 mm
Height	222 mm
Depth	60 mm
Width with packaging	222 mm
Height with packaging	222 mm
Depth with packaging	60 mm
Packing unit	1 piece
Range	C
GTIN (EAN)	4012799921127

Dimensioned drawing [mm]

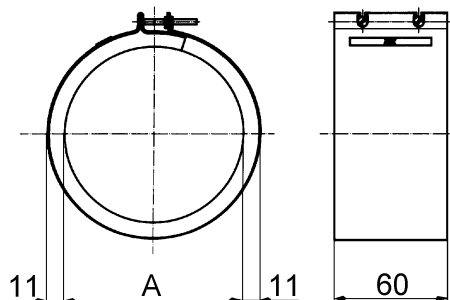

A
200

Shown in installed state. Supplied in elongated form.