

ELR 31



Short description

Fixing cuffs for sound and vibration dampening of duct fans, DN 315

Article number 0092.0114

Technical data

Material	Sheet steel, galvanised
Weight	0,4 kg
Weight including packaging	0,4 kg
Suitable for nominal size	315 mm
Width	337 mm
Height	337 mm
Depth	60 mm
Width with packaging	337 mm
Height with packaging	337 mm
Depth with packaging	60 mm
Packing unit	1 piece
Range	C
GTIN (EAN)	4012799921141

Dimensioned drawing [mm]

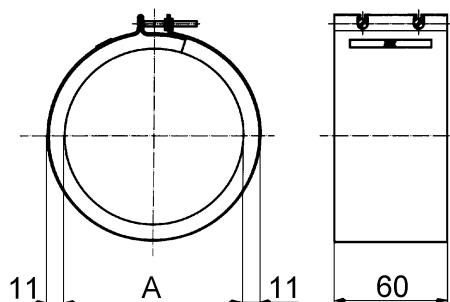

A

 315
 Shown in installed state. Supplied in elongated form.