

ELR 35



Short description

Fixing cuffs for sound and vibration dampening of duct fans, DN 350

Article number 0092.0115

Technical data

Material	Sheet steel, galvanised
Weight	0,4 kg
Weight including packaging	0,44 kg
Suitable for nominal size	350 mm
Width	377 mm
Height	377 mm
Depth	60 mm
Width with packaging	377 mm
Height with packaging	377 mm
Depth with packaging	60 mm
Packing unit	1 piece
Range	C
GTIN (EAN)	4012799921158

Dimensioned drawing [mm]

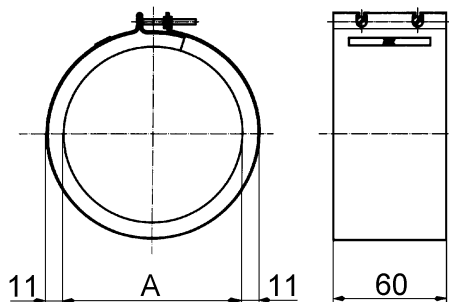

A

355

Shown in installed state. Supplied in elongated form.