

ER 60 EVZ



Short description

Fan insert with cover and filter for installation in ER-UP/GH recessed-mounted housing, air volume 61 m³/h, with time delay switch

Application examples

Bathroom, Kitchen, Multiple family unit, Day room, Dining room

Article number 0084.0372

Technical data

Model	Time delay switch
Air flow volume	61 m ³ /h
Rotating speed	1.250 1/min
Air direction	Air extraction
Speed controllable	–
Type of voltage	Alternating current
Rated voltage	230 V
Frequency	50 Hz
Power consumption	21 W
I _{max}	0,17 A
Degree of protection	IP X5
Mains cable	5 x 1,5 mm ²
Installation site	Wall / Ceiling
Type of installation	Recessed-mounted
System type	Decentralised
Material	Synthetic material
Colour	Traffic white, similar to RAL 9016
Filter class	ISO Coarse 30 % (G2)
Air outlet direction	at rear
Airstream temperature at I _{Max}	40 °C
Sound pressure level	40 dB(A) (Specifications in accordance with DIN 18017-3 at an equivalent absorption area A _L = 10 m. ²)
Packing unit	1 piece
GTIN (EAN)	4012799843726

ER 60 EVZ

Sound power level in octave range

	63 Hz	125 Hz	250 Hz	500 Hz	1 kHz	2 kHz	4 kHz	8 kHz	Total
L_{WA7, high} (dB(A))	-	-	-	-	-	-	-	-	43

L_{WA7}= housing and free inlet sound power level in dB.

Characteristic curve

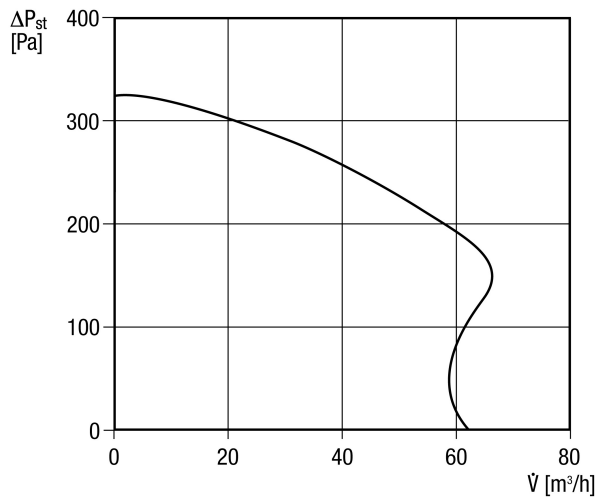

Dimensioned drawing [mm]

Fan insert ER ... E with ER-UP/GH recess-mounted housing

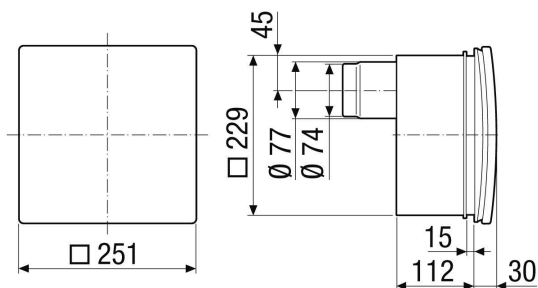

ER 60 EVZ

Dimensioned drawing [mm]

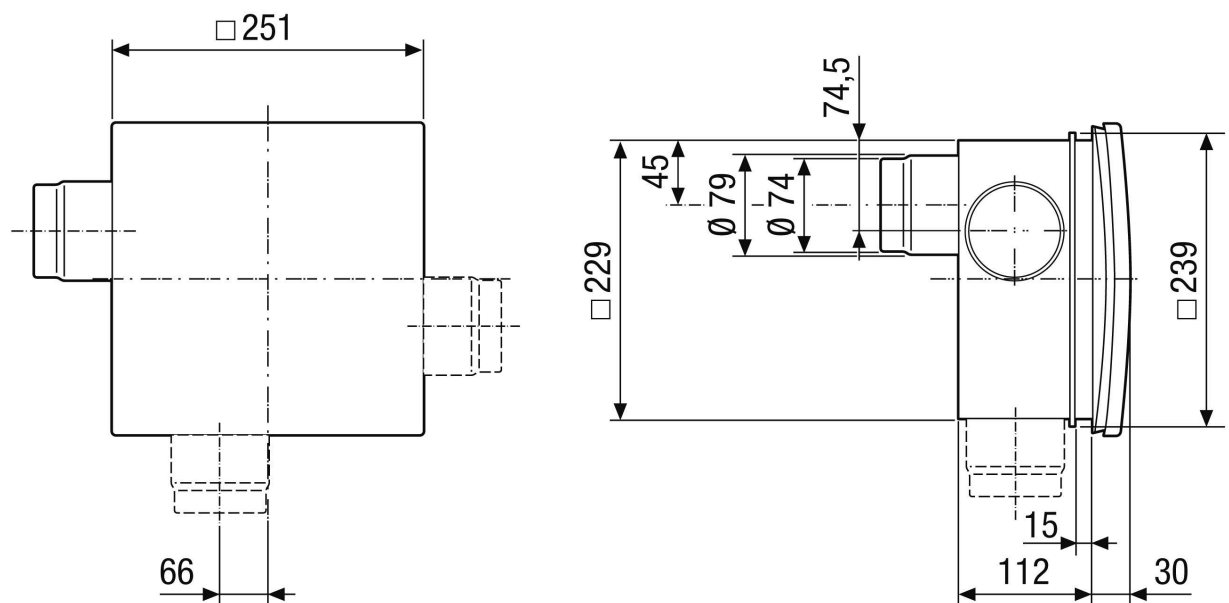

Fan insert ER ... E with ER-UP/GH recess-mounted housing and second room connection