

EZR 30/6 B



Short description

Axial duct fan, DN 300, alternating current

Application examples

Machine extraction unit, Showroom, Foreman's office, Workshop, Production site

Article number 0086.0003

Technical data

Air flow volume	1.200 m³/h
Rotating speed	930 1/min
Impeller type	axial
Speed controllable	✓
Reversing capacity	✓
Type of voltage	Alternating current
Rated voltage	230 V
Frequency	50 Hz
Nominal output	59 W
I _{nom}	0,3 A
I _{max}	0,32 A
Degree of protection	IP 55
Insulation class	B
Pole-changeable	–
Installation position	horizontal / vertical
Material	Sheet steel, galvanised
Colour	Silver
Weight	8,43 kg
Weight including packaging	9,24 kg
Nominal size	300 mm
Width	380 mm
Height	424 mm
Depth	300 mm
Width with packaging	420 mm
Height with packaging	430 mm
Depth with packaging	330 mm
Airstream temperature at nominal current	60 °C
Airstream temperature at I _{Max}	-20 °C up to 60 °C
Packing unit	1 piece

EZR 30/6 B

Range	C
GTIN (EAN)	4012799860037

Sound power level in octave range

	63 Hz	125 Hz	250 Hz	500 Hz	1 kHz	2 kHz	4 kHz	8 kHz	Total
L_{WA2}, S1 (dB(A))	15	27	22	18	21	13	17	15	30
L_{WA2}, S2 (dB(A))	14	38	36	31	34	30	25	23	42
L_{WA2}, S3 (dB(A))	16	39	36	36	38	35	29	25	44
L_{WA2}, S4 (dB(A))	18	38	37	42	39	36	30	25	46
L_{WA2}, S5 (dB(A))	18	42	38	43	40	37	31	25	48
L_{WA5}, S1 (dB(A))	20	31	37	30	28	25	19	15	39
L_{WA5}, S2 (dB(A))	20	40	53	44	44	45	35	24	54
L_{WA5}, S3 (dB(A))	21	39	49	55	47	48	40	27	57
L_{WA5}, S4 (dB(A))	21	40	50	56	48	49	41	28	58
L_{WA5}, S5 (dB(A))	22	46	50	56	48	50	42	28	59
L_{WA6}, S1 (dB(A))	24	29	31	35	32	29	18	14	39
L_{WA6}, S2 (dB(A))	26	45	48	50	48	48	36	25	55
L_{WA6}, S3 (dB(A))	28	45	47	55	53	53	51	48	60
L_{WA6}, S4 (dB(A))	27	45	47	47	57	53	48	43	61
L_{WA6}, S5 (dB(A))	27	46	48	58	53	54	46	36	61

L_{WA2}= housing sound power level in dB.

L_{WA5}= free inlet sound power level in dB.

L_{WA6}= free outlet sound power level in dB.

EZR 30/6 B

Characteristic curve

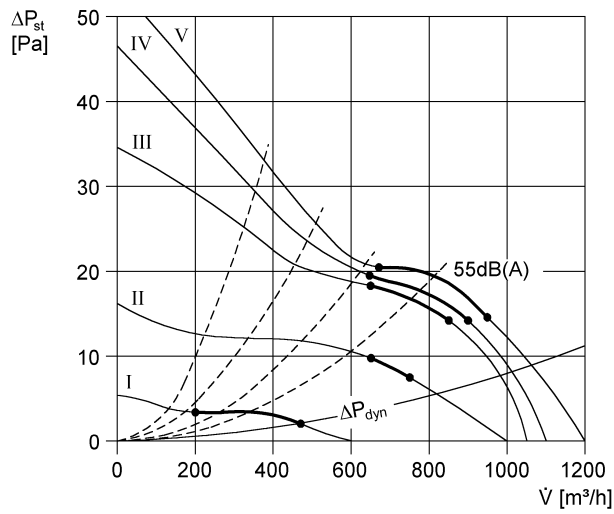

Dimensioned drawing [mm]

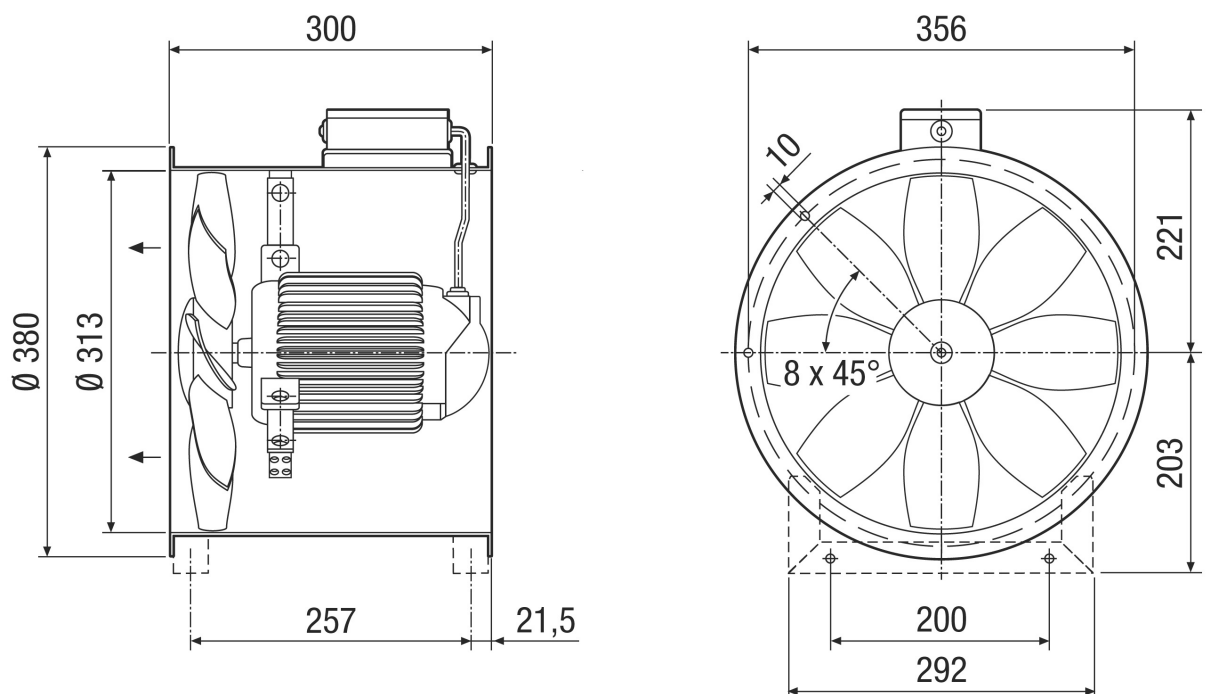

Number of flange holes: 8