

FU 30

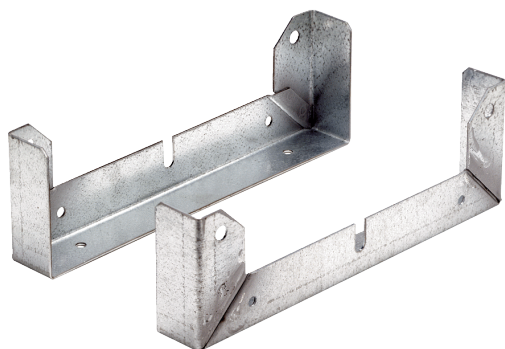

Short description

Mounting foot for the assembly of EZL/DZL and EZR/DZR fans on walls, ceilings or brackets, DN 300

Article number 0036.0071

Technical data

Material	Sheet steel, galvanised
Weight	0,5 kg
Weight including packaging	1,03 kg
Suitable for nominal size	300 mm
Width	292 mm
Height	93 mm
Depth	40 mm
Width with packaging	292 mm
Height with packaging	93 mm
Depth with packaging	40 mm
Packing unit	2 pieces
Range	C
GTIN (EAN)	4012799360711

Dimensioned drawing [mm]

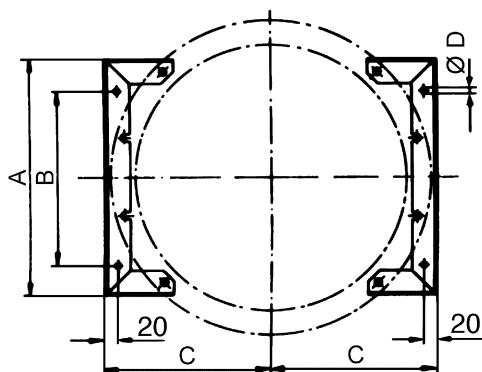

A	B	C	D
292	200	203	7