

FU 45

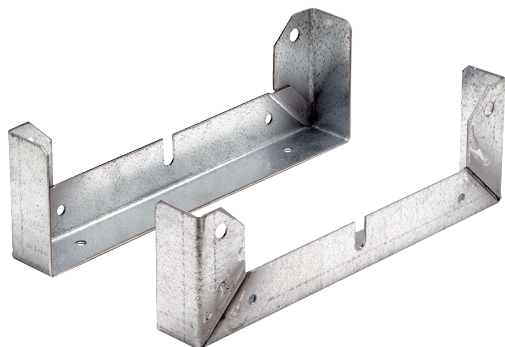

Short description

Mounting foot for the assembly of EZL/DZL and EZR/DZR fans on walls, ceilings or brackets, DN 450

Article number 0036.0074

Technical data

Material	Sheet steel, galvanised
Weight	0,66 kg
Weight including packaging	1,34 kg
Suitable for nominal size	450 mm
Width	385 mm
Height	115 mm
Depth	40 mm
Width with packaging	385 mm
Height with packaging	115 mm
Depth with packaging	40 mm
Packing unit	2 pieces
Range	C
GTIN (EAN)	4012799360742

Dimensioned drawing [mm]

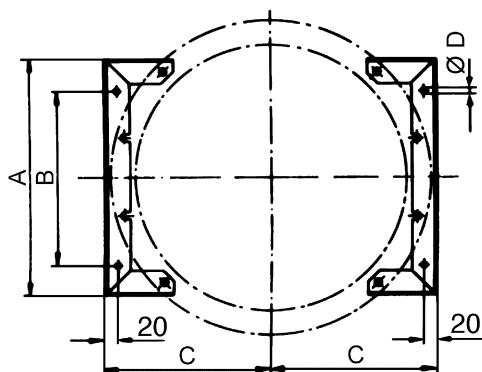

A	B	C	D
385	280	274	7