

FU 60

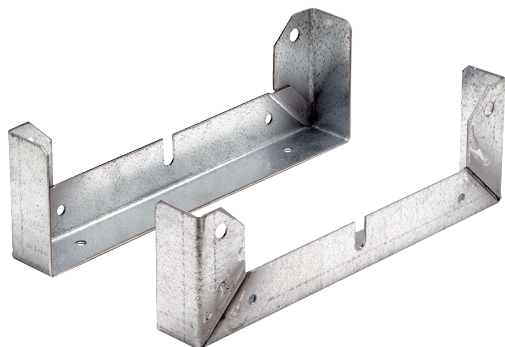

Short description

Mounting foot for the assembly of EZL/DZL and EZR/DZR fans on walls, ceilings or brackets, DN 600

Article number 0036.0077

Technical data

Material	Sheet steel, galvanised
Weight	1,1 kg
Weight including packaging	2,23 kg
Suitable for nominal size	600 mm
Width	517 mm
Height	145 mm
Depth	40 mm
Width with packaging	517 mm
Height with packaging	145 mm
Depth with packaging	40 mm
Packing unit	2 pieces
Range	C
GTIN (EAN)	4012799360773

Dimensioned drawing [mm]

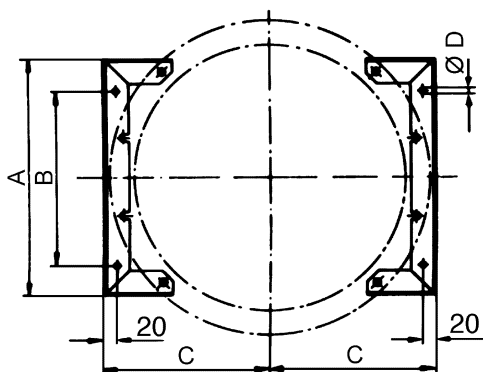

A	B	C	D
517	400	345	11