

GPI 10-20

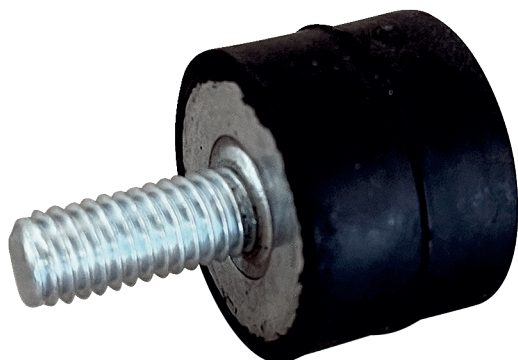

Short description

4 vibration dampers for the vibration-damped mounting of DAR/DAR Ex, load capacity 10 - 20 kg

Article number 0073.0273

Technical data

Material	Steel/plastic
Colour	Black
Weight	0,02 kg
Weight including packaging	0,02 kg
Maximum working load	20 kg
Minimum working load	10 kg
Width	20 mm
Height	15 mm
Depth	20 mm
Width with packaging	20 mm
Height with packaging	15 mm
Depth with packaging	20 mm
Packing unit	1 piece
Range	C
GTIN (EAN)	4012799732730

Dimensioned drawing [mm]

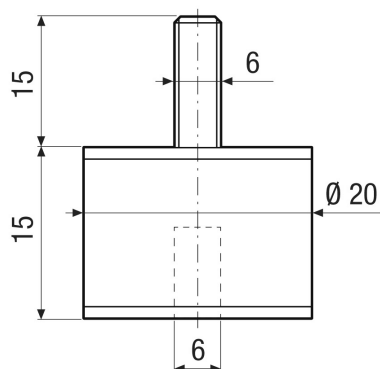

GPI 10-20

