

GPI 131-220

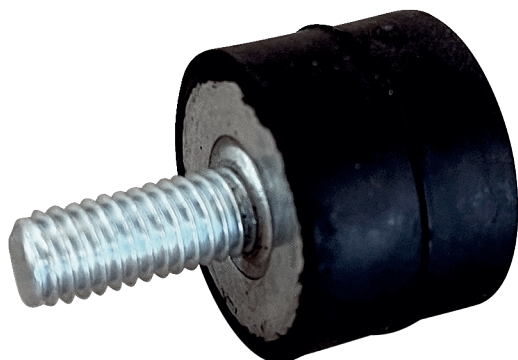

Short description

4 vibration dampers for the vibration-damped mounting of DAR/DAR Ex, load capacity 131 - 220 kg

Article number 0073.0277

Technical data

Material	Steel/plastic
Colour	Black
Weight	0,4 kg
Weight including packaging	0,4 kg
Maximum working load	220 kg
Minimum working load	131 kg
Width	75 mm
Height	50 mm
Depth	75 mm
Width with packaging	75 mm
Height with packaging	50 mm
Depth with packaging	75 mm
Packing unit	1 piece
Range	C
GTIN (EAN)	4012799732778

Dimensioned drawing [mm]

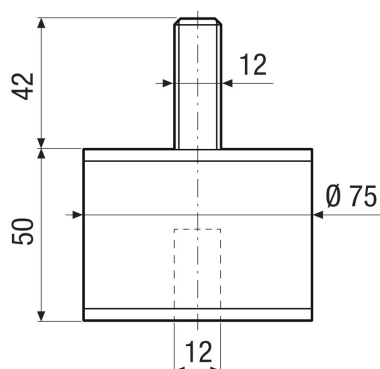

GPI 131-220

