

GPI 46-65

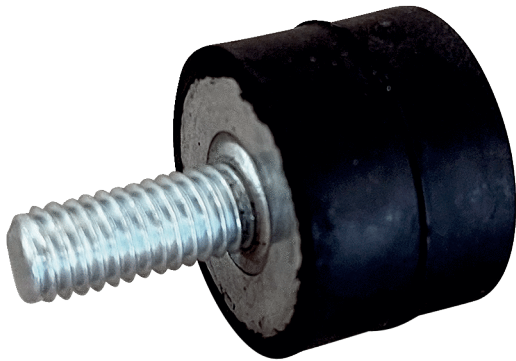

Short description

4 vibration dampers for the vibration-damped mounting of DAR/DAR Ex, load capacity 46 - 65 kg

Article number 0073.0275

Technical data

Material	Steel/plastic
Colour	Black
Weight	0,09 kg
Weight including packaging	0,09 kg
Maximum working load	65 kg
Minimum working load	46 kg
Width	40 mm
Height	30 mm
Depth	40 mm
Width with packaging	40 mm
Height with packaging	30 mm
Depth with packaging	40 mm
Packing unit	1 piece
Range	C
GTIN (EAN)	4012799732754

Dimensioned drawing [mm]

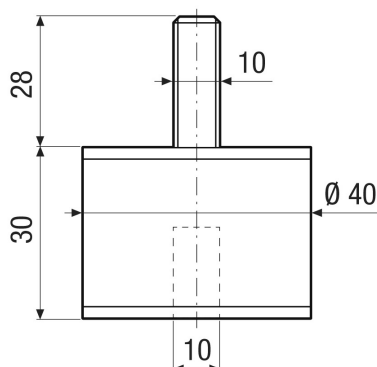

GPI 46-65

