

GRM ES 10/2 Ex



Short description

Centrifugal blower with stainless steel housing, size 100, three-phase AC, for use in potentially explosive atmospheres, medium: gas

Application examples

explosion-proof industrial applications

Article number 0073.0391

Technical data

Air flow volume	430 m ³ /h
Rotating speed	2.880 1/min
Impeller type	radial
Speed controllable	✓
Reversing capacity	–
Type of voltage	Three-phase AC
Rated voltage	400 V
Frequency	50 Hz
Nominal output	90 W
I _{nom}	0,53 A
Degree of protection	IP 55
Insulation class	F
Pole-changeable	–
Installation site	Duct connection
Installation position	Horizontal
Housing material	Stainless steel (AISI 304)
Colour	Silver
Weight	4 kg
Weight including packaging	7,5 kg
Width	220 mm
Height	229 mm
Depth	198 mm
Width with packaging	315 mm
Height with packaging	300 mm
Depth with packaging	240 mm
EX designation in accordance with the ATEX Directive	Ex II 2 G
EX designation in accordance with standard	Ex db IIB+H2 T4 Gb X / Ex h IIB+H2 T4 Gb X
Ta ambient temperature	-20 °C ≤ Ta ≤ +40 °C
Operating mode	S1

GRM ES 10/2 Ex

PTC DIN 44082	M 100
Temperature class	T4
Packing unit	1 piece
Range	C
GTIN (EAN)	4012799733911

Sound power level in octave range

	63 Hz	125 Hz	250 Hz	500 Hz	1 kHz	2 kHz	4 kHz	8 kHz	Total
L_{WA5, S5} (dB(A))	45	57	62	66	71	64	56	46	73

L_{WA5}= free inlet sound power level in dB.

Characteristic curve

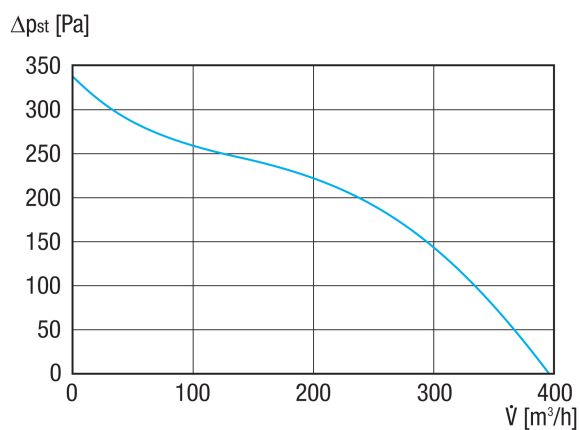

GRM ES 10/2 Ex

Dimensioned drawing [mm]

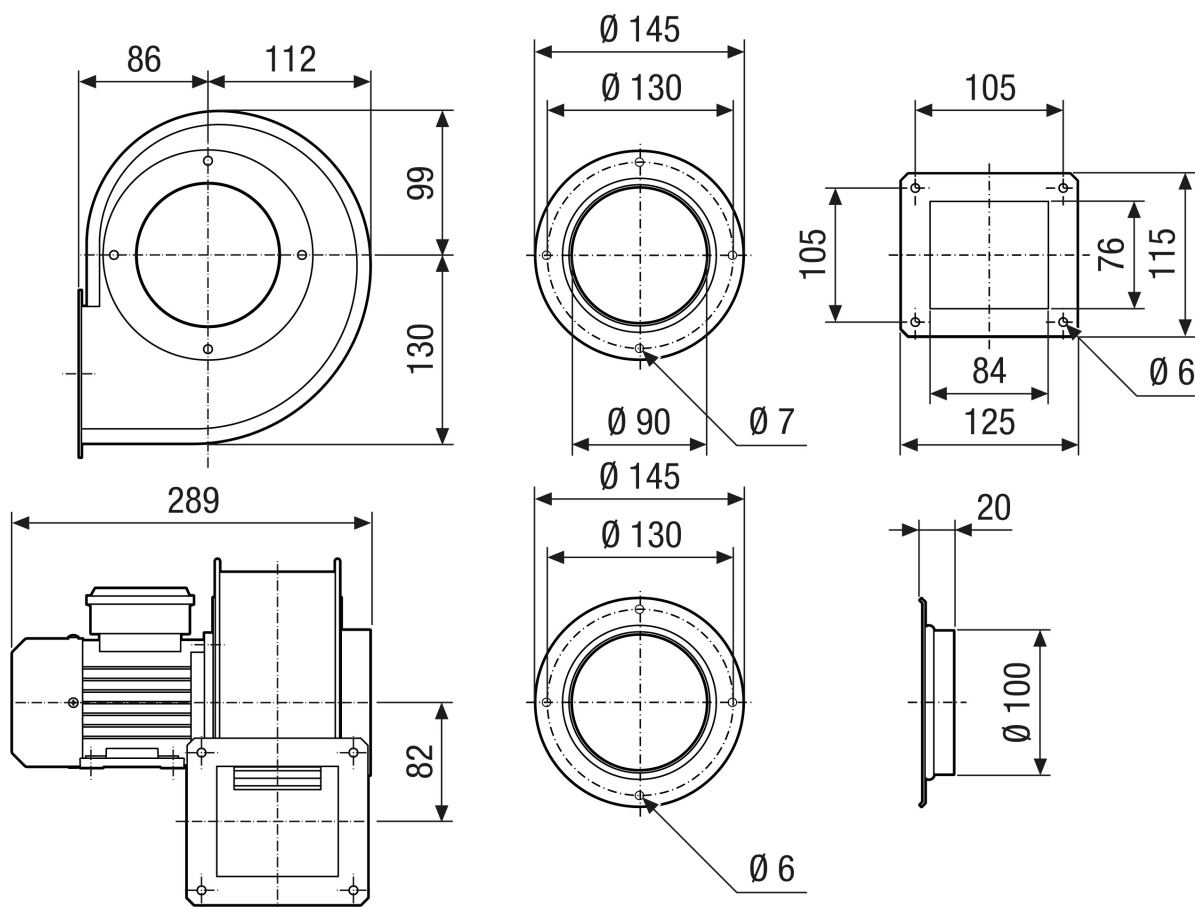

GRM ES 10/2 Ex

Dimensioned drawing Housing orientation [mm]

①						
	0°	45°	90°	135°	270°	315°
②						

① Right-hand version

② Left-hand version

This size cannot be ordered in the versions 45°, 135°, 315°