

GS 25



Short description

Counter socket for fitting DN 250 flexible cuffs on ventilation ducts

Article number 0055.0169

Technical data

Material	Sheet steel, galvanised
Weight	0,48 kg
Weight including packaging	0,5 kg
Suitable for nominal size cuffs	250 mm
Width	304 mm
Height	304 mm
Depth	8 mm
Width with packaging	304 mm
Height with packaging	304 mm
Depth with packaging	8 mm
Packing unit	1 piece
Range	C
GTIN (EAN)	4012799551690

Dimensioned drawing [mm]

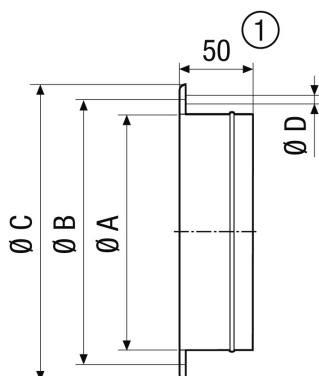

A	B	C	D
263	286	304	8

① GS 56: 55 mm