

GS 35



Short description

Counter socket for fitting DN 350 flexible cuffs on ventilation ducts

Article number 0055.0171

Technical data

Material	Sheet steel, galvanised
Weight	0,7 kg
Weight including packaging	0,72 kg
Suitable for nominal size cuffs	350 mm
Width	420 mm
Height	420 mm
Depth	50 mm
Width with packaging	420 mm
Height with packaging	420 mm
Depth with packaging	50 mm
Packing unit	1 piece
Range	C
GTIN (EAN)	4012799551713

Dimensioned drawing [mm]

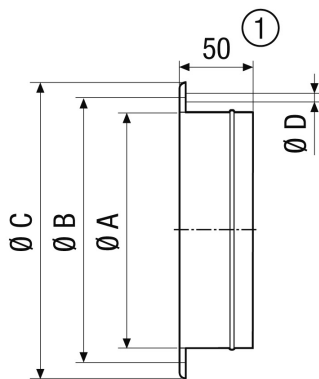

A	B	C	D
363	395	420	10

① GS 56: 55 mm