

GS 45



Short description

Counter socket for fitting DN 450 flexible cuffs on ventilation ducts

Article number 0055.0173

Technical data

Material	Sheet steel, galvanised
Weight	0,86 kg
Weight including packaging	0,9 kg
Suitable for nominal size cuffs	450 mm
Width	512 mm
Height	512 mm
Depth	50 mm
Width with packaging	512 mm
Height with packaging	512 mm
Depth with packaging	50 mm
Packing unit	1 piece
Range	C
GTIN (EAN)	4012799551737

Dimensioned drawing [mm]

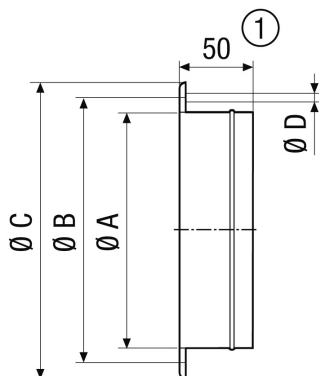

A	B	C	D
458	487	512	10

① GS 56: 55 mm