

# GS 60



## Short description

Counter socket for fitting DN 600 flexible cuffs on ventilation ducts

Article number 0055.0175

## Technical data

Material	Sheet steel, galvanised
Weight	2,16 kg
Weight including packaging	2,2 kg
Suitable for nominal size cuffs	600 mm
Width	710 mm
Height	710 mm
Depth	50 mm
Width with packaging	710 mm
Height with packaging	710 mm
Depth with packaging	50 mm
Packing unit	1 piece
Range	C
GTIN (EAN)	4012799551751

## Dimensioned drawing [mm]

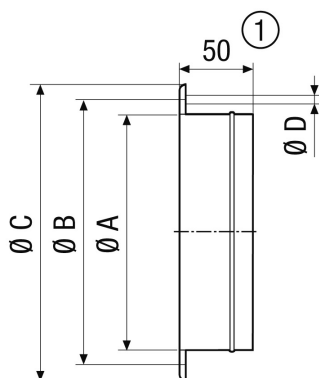

A	B	C	D
613	674	710	14

① GS 56: 55 mm